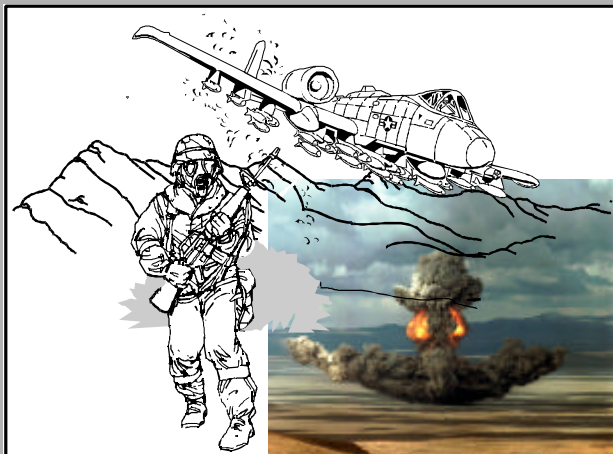




**AIR FORCE HANDBOOK 32-4014,  
Volume 4  
1 March 1998**

**USAF ABILITY TO SURVIVE AND  
OPERATE PROCEDURES IN A  
NUCLEAR, BIOLOGICAL, AND  
CHEMICAL (NBC) ENVIRONMENT**



**DEPARTMENT OF THE AIR FORCE**



---

*BY ORDER OF THE  
SECRETARY OF THE AIR FORCE*

*AIR FORCE HANDBOOK 32-4014,  
VOLUME 4  
1 March 1998*

---

*Civil Engineer*

**USAF OPERATIONS IN A CHEMICAL AND  
BIOLOGICAL WARFARE (CB) ENVIRONMENT,  
SURVIVE TO OPERATE PROCEDURES**

---

This handbook implements AFPD 32-40, Disaster Preparedness, and AFMAN 32-4005, Personnel Protection and Attack Actions. AFH 32-4014, Volume 4, provides key information, procedures, and actions needed to prepare for, survive, and restore mission capability after, a nuclear, biological, chemical, or conventional attack. The primary emphasis, however, is the CB environment. This handbook is designed for all USAF personnel stationed in, or deployable to a CB high threat area. Information on planning and analysis, CB hazards, and CB defense equipment can be found in Volumes 1, 2, and 3 respectively. Send comments and suggested improvements to HQ AFCESA/CEX, 139 Barnes Drive, Tyndall AFB FL 32403-5319.

OPR: HQ AFCESA/CEXR (MSgt Steven J. Reed)  
Certified by: HQ AFCESA/CEX (Colonel Randall L. Turner)  
Pages: 155/Distribution: F



	<b>PAGE</b>
CHAPTER 1 - WHAT HAPPENS UPON ARRIVAL.....	7
1.1. GENERAL.....	7
1.2. DESTINATIONS.....	7
1.3. ARRIVAL.....	7
1.4. BRIEFINGS.....	8
1.5. MOBILITY BAGS.....	10
1.6. HEALTH AND FIRST-AID/BUDDY CARE.....	11
1.7. COMMAND AND CONTROL.....	12
1.8. BASE OPERATING SUPPORT.....	12
CHAPTER 2 - PREPARING FOR HOSTILITIES.....	15
2.1. LAW OF ARMED CONFLICT (LOAC).....	15
2.2. RULES OF ENGAGEMENT (ROE).....	15
2.3. THE CODE OF CONDUCT.....	16
2.4. THREAT AWARENESS.....	17
2.5. PASSIVE DEFENSE.....	19
2.6. AIR BASE DEFENSE (ABD).....	23
2.7. ATTACK ALARM SIGNALS.....	24
2.8. MISSION-ORIENTED PROTECTIVE POSTURE (MOPP).....	26
CHAPTER 3 - WHAT TO DO IF THERE IS AN ATTACK.....	32
3.1. REPORT THE ATTACK.....	31
3.2. SEEK COVER.....	31
CHAPTER 4 - BASE RECOVERY AFTER ATTACK.....	33
4.1. AFTER AN ATTACK.....	33
4.2. RECOVERY FROM AN ATTACK.....	34
4.3. POST-ATTACK REPORTING.....	35
4.4. "BRAAT KIT".....	36
4.5. EXPLOSIVE ORDNANCE RECONNAISSANCE (EOR).....	39
4.6. DECONTAMINATION.....	53
4.7. CONTAMINATION CONTROL AREA (CCAs).....	55
CHAPTER 5 - CHEMICAL WARFARE DEFENSE.....	58
5.1. THREAT.....	58
5.2. CHEMICAL AGENTS.....	58

5.3. CHEMICAL WARFARE AGENT ANTIDOTES.....	64
5.4. CHEMICAL AGENT DETECTION.....	71
5.5. CHEMICAL CONTAMINATION CONTROL.....	76
CHAPTER 6 - INDIVIDUAL PROTECTIVE EQUIPMENT.....	83
6.1. MASK, MCU-2A/P.....	83
6.2. MASK, M17A2.....	97
6.3. GROUND CREW ENSEMBLE.....	109
6.4. HEAT STRESS.....	117
CHAPTER 7 - BIOLOGICAL WARFARE DEFENSE.....	118
7.1. CLASSIFICATION OF BIOLOGICAL AGENTS.....	118
7.2. BIOLOGICAL AGENT EFFECTIVENESS.....	119
7.3. CHARACTERISTICS OF BIOLOGICAL AGENTS.....	119
7.4. PROTECTIVE MEASURES.....	121
7.5. BIOLOGICAL DECONTAMINATION.....	122
CHAPTER 8 - NUCLEAR WARFARE DEFENSE ACTIONS & DEPLETED URANIUM SAFETY.....	123
8.1. INTRODUCTION.....	123
8.2. NUCLEAR DETONATIONS.....	123
8.3. NUCLEAR YIELD.....	125
8.4. NUCLEAR DETONATION EFFECTS.....	126
8.5. TYPES OF RADIATION.....	127
8.6. PROTECTIVE MEASURES.....	128
8.7. RADIATION SICKNESS.....	129
8.8. NUCLEAR CONTAMINATION AVOIDANCE.....	130
8.9. NUCLEAR DECONTAMINATION.....	131
8.10. DEPLETED URANIUM (DU).....	131
CHAPTER 9 - COMMAND AND CONTROL.....	133
9.1. THE COMMAND POST.....	133
9.2. THE SURVIVAL RECOVERY CENTER (SRC).....	133
9.3. UNIT CONTROL CENTERS.....	135
CHAPTER 10 - SELF AID AND BUDDY CARE.....	138
10.1. FIRST AID FUNDAMENTALS.....	138
CHAPTER 11 - AUXILIARY FIRE FIGHTING.....	150

11.1. FIRE REPORTING AND FIGHTING.....	150
--	-----

<b>Tables</b>	<b>Page</b>
TABLE 1.1. PERSONAL/GENERAL ACTIONS CHECKLIST ITEMS ...	8
TABLE 2.1. THREATCON DEFINITIONS AND ACTIONS.....	18
TABLE 2.2. MOPP NOTES & OPTIONS.....	30
TABLE 4.1. POST-ATTACK DAMAGE & CASUALTY CHECKLIST ITEMS.....	38
TABLE 4.2. UNEXPLODED ORDNANCE (UXO) CHECKLIST ITEMS	42
TABLE 4.3. UXO IDENTIFICATION GUIDE.....	43
TABLE 4.4. DECONTAMINATION LEVELS.....	54
TABLE 5.1. CHEMICAL WARFARE (CW) AGENT HAZARDS.....	60
TABLE 5.2. NERVE AGENT SYMPTOMS & PROTECTION .....	61
TABLE 5.3. BLISTER AGENT SYMPTOMS & PROTECTION.....	63
TABLE 5.4. BLOOD AGENT SYMPTOMS & PROTECTION.....	63
TABLE 5.5. CHOKING AGENT SYMPTOMS & PROTECTION .....	64
TABLE 5.6. M8 AND M9 DETECTION PAPER. ....	75
TABLE 5.7. DECONTAMINATION METHODS. ....	77
TABLE 5.8. M291 SKIN DECONTAMINATING KIT. ....	79
TABLE 5.9. M295 SKIN DECONTAMINATING KIT .....	80
TABLE 5.10. M258A1 SKIN DECONTAMINATING KIT. ....	81
TABLE 6.1. INSPECTING THE MCU-2/AP MASK. ....	87
TABLE 6.2. CANISTERS AND FILTERS. ....	90
TABLE 6.3. MCU-2A/P FITTING PROCEDURES. ....	91
TABLE 6.4. MCU-2A/P DONNING PROCEDURES. ....	93
TABLE 6.5. INSPECTING THE M17A2 MASK. ....	101
TABLE 6.6. M17A2 FITTING PROCEDURES.....	103
TABLE 6.7. M17A2 DONNING PROCEDURES. ....	105
TABLE 6.8. BATTLE DRESS OVERGARMENT.....	112
TABLE 6.9. DONNING AND DOFFING THE BDO OVERGARMENT.	113
TABLE 6.10. JOINT SERVICE LIGHTWEIGHT INTEGRATED SUIT TECHNOLOGY. ....	114

TABLE 6.11. DONNING AND DOFFING THE JSLIST  
OVERGARMENT .....115

TABLE 10.1. BASIC LIFE SAVING STEPS.....138

TABLE 10.2. GENERAL NOTES FOR CARE WHILE DEPLOYED....138

TABLE 10.3. HEALTH HAZARDS AND PRECAUTIONS. ....139

TABLE 10.4. PSYCHOLOGICAL EMERGENCIES. ....141

TABLE 10.5. COLD RELATED INJURIES AND TREATMENT. ....142

TABLE 10.6. SHOCK SYMPTOMS AND TREATMENT. ....143

TABLE 10.7. INJURY RECOGNITION AND TREATMENT.....144

TABLE 10.8. FRACTURES RECOGNITION AND TREATMENT. ....146

TABLE 10.9. BURNS AND HEAT INJURIES AND TREATMENT. ....148

TABLE 11.1. FIRE REPORTING & FIGHTING PROCEDURES.....150

TABLE 11.2. BASIC FIRE FIGHTING METHODS.....151

<b>Figures</b>	<b>Page</b>
FIGURE 2.1. USAF STANDARDIZED ALARM SIGNALS.....	25
FIGURE 2.2. MOPP 0 AND 1. ....	27
FIGURE 2.3. MOPP 2 AND 3. ....	28
FIGURE 2.4. MOPP 4 AND ALPHA. ....	29
FIGURE 4.1. STANDARD UXO MARKER. ....	40
FIGURE 5.1. NERVE AGENT ANTIDOTE INJECTORS. ....	65
FIGURE 5.2. AUTOINJECTOR SITES. ....	67
FIGURE 5.3. AUTOMATIC LIQUID AGENT MONITOR (ALAD).....	72
FIGURE 5.4. M22 ALARM, AUTOMATIC CHEMICAL AGENT.....	73
FIGURE 5.5. M8 AND M9 PAPER. ....	74
FIGURE 6.1. MCU-2A/P MASK. ....	83
FIGURE 6.2. MCU-2A/P PROTECTIVE MASK. ....	86
FIGURE 6.3. M17A2 MASK. ....	97
FIGURE 9.1. TYPICAL SRC COMMAND AND CONTROL RELATIONSHIP. ....	135



**ATTACHMENTS**

**Page**

ABBREVIATIONS, ACRONYMS, AND TERMS

155

## **CHAPTER 1 - WHAT HAPPENS UPON ARRIVAL**

### **1.1. General.**

This chapter explains what you can expect when you arrive at your deployment location.

### **1.2. Destinations.**

When deployed, we may operate from many different locations. We may be at established air bases near large cities or at bare bases with little in terms of facilities or support.

### **1.3. Arrival.**

Upon arrival at your deployment location, you should go through in-processing, receive briefings, and retrieve the mobility bags issued at home station. If you are the first to arrive at a bare base, you may not receive the briefings or they may be delayed until initial beddown actions are complete. You should also review any “functional” checklists to ensure all the actions concerning your particular area of responsibility are covered. See Table 1.1. for some checklist items.

<b>TABLE 1.1. PERSONAL/GENERAL ACTIONS CHECKLIST ITEMS</b>
Use the following checklists items as a guide along with locally developed checklists tailored for the deployment location.
<b>1. Accomplish your personal actions</b>
<ul style="list-style-type: none"> <li><input checked="" type="checkbox"/> Determine where the nearest shelter/bunkers are compared to where you live and work.</li> <li><input checked="" type="checkbox"/> Know where your weapon is located or stored.</li> <li><input checked="" type="checkbox"/> If assigned a vehicle:</li> <li><input checked="" type="checkbox"/> Ensure blackout is accomplished: <ul style="list-style-type: none"> <li>– All chrome is covered or painted.</li> <li>– Head and tail lights are covered with tape.</li> </ul> </li> <li><input checked="" type="checkbox"/> Attach detection paper to the flat surfaces (such as hood, bumpers, trunk lid) and on the fenders behind the wheel wells, and over the door handles.</li> </ul>
<b>2. Accomplish your general actions</b>
<ul style="list-style-type: none"> <li><input checked="" type="checkbox"/> Disperse and splinter protect critical assets.</li> <li><input checked="" type="checkbox"/> Implement camouflage, concealment and deception (CCD) procedures.</li> <li><input checked="" type="checkbox"/> Implement contamination avoidance procedures. Protect critical equipment/vehicles by placing indoors or cover with tarps, natural cover, etc.</li> <li><input checked="" type="checkbox"/> Implement blackout procedures.</li> </ul>

#### **1.4. Briefings.**

As a minimum you should receive briefings on:

1.4.1. Attack alarm signals/warning systems at the deployed location (sirens, giant voice, flags, lights, etc.) See paragraph 2.4. and Figure 2.1. for standard alarm signals.

- 1.4.2. Blackout procedures. See paragraph 2.5.4.
- 1.4.3. Threat condition (ThreatCon) See Table 2.1. for ThreatCon definitions and actions.
- 1.4.4. Mission Oriented Protective Posture (MOPP) level. See paragraph 2.8. for a description of MOPP.
- 1.4.5. Contamination Control Area (CCA) locations.
- 1.4.6. Location of personnel shelters and protective bunkers.
- 1.4.7. Location and phone numbers of various units.
- 1.4.8. Billeting and feeding procedures and locations.
- 1.4.9. Explosive Ordnance Reconnaissance (EOR) safety requirements.
- 1.4.10. Fire safety. Topics normally include: reporting and evacuation procedures (See Table 11.1.), tent city fire safety rules, location of fire alarms and smoking areas, and procedures for adjusting tent heaters.
- 1.4.11. Military intelligence. Topics normally include local terrorist/crime threat, customs that may be offensive to our hosts, and procedures for local security.
- 1.4.12. Anything unique to the deployment location.

### **1.5. Mobility Bags.**

There are A, B, C, and D-bags. Which bags you were issued depends on the location of your deployment and your Air Force Specialty (AFS).

1.5.1. **A-bag, General Support.** Issued to all mobility personnel and contains basic items such as field gear, sleeping bag, and mess kit.

1.5.2. **B-bag, Artic.** Issued based on the climate of your location; it includes items such as mittens, parka, underwear, and other items to help keep you warm.

1.5.3. **C-bag, Chemical Warfare.** Issued if you are deploying to a chemical-biological (CB) high threat area. You will deploy with a C-1 bag containing two complete ground crew ensembles, M8/M9 paper, decontamination kits, and a canteen cap. Two additional ground crew ensembles will be either be palletized and shipped to the deployed location or shipped from the Air Force Consolidated Mobility Bag Control Center (CMBCC).

1.5.4. **D-bag, Aircrew Chemical Warfare.** Contains aircrew CB protective equipment. Upon deployment, aircrew members should have checked or hand-carried a mini D-bag (containing one complete aircrew ensemble) onto the aircraft. The remaining D-bag items should have been floor loaded or palletized and shipped as cargo.

**Note:** For aircrew flying operations in a CB environment use this handbook in conjunction with MCI 11-series, Volume 20, Aircrew Chemical Operations and Procedures.

## **1.6. Health and First-Aid/Buddy Care.**

Chapter 10 provides information with includes quick reference health and treatment tables.

**1.6.1. Personal Hygiene.** In the field, you should frequently wash your hands; practice proper dental care; maintain clean, dry clothing; change your socks daily; use foot powder to prevent fungal infections; and bathe in approved, safe water as often as practical. If a shower is not available, you should wash sites of perspiration. The personal hygiene measures will definitely prevent certain illnesses/conditions (and will help morale). Being in general good health also supports the body in fighting off infections and other illnesses better than if your health is already compromised. These everyday efforts will go a long way to ensuring a healthy environment.

**1.6.2. Mental Stress.** Mental stress is normal during deployments, it can affect you before, during, or after an operation, and if allowed to build up, it can degrade health and performance. Seek relief by talking to your buddies, your supervisor, chaplains, or medical counselors.

### **1.7. Command and Control.**

A lot of people and equipment will be arriving from many locations, and our goal is to integrate all of those resources into a comprehensive operation that includes: a command post, or wing operations center (WOC), a survival recovery center (SRC), and unit control centers. Chapter 9 provides a brief breakdown of some of the ways command and control ( $C^2$ ) may be set up where you deploy. However, keep in mind that the actual  $C^2$  structure will depend on where you are and who is deployed with you.

### **1.8. Base Operating Support.**

The level of support at deployed locations varies depending on the number of people deployed and the nature of the deployment. A main operating base (MOB) will have a full range of support functions, while support at a bare base will be limited, especially in the first days of the deployment. However, no matter where you are deployed, you should have essential billeting and food service functions. You also may encounter tasks that you're normally not accustomed to such as beddown, security etc.

**1.8.1. Civil Engineer.** Prime Base Engineer Emergency Force (BEEF) forces maintain a highly mobile military combat support civil engineer force capable of rapid response in support of worldwide contingency operations. Emergency repair of air bases, force beddown, operation and maintenance of AF facilities, rendering safe and disposal of explosive ordnance, and

monitoring and protecting resources subject to conventional, chemical, biological, and nuclear attacks are some of the key Prime BEEF missions.

1.8.2. **Personnel** support will be available at most deployed locations and is usually provided by a Personnel Support for Contingency Operations (PERSCO) team.

1.8.3. **Finance** service is sometimes limited to cashing checks and providing answers to pay inquiries. The deployed finance office normally does not process changes to your military pay entitlements. It is important that you take care of your financial affairs before you deploy.

1.8.4. **Services.** Prime Readiness in Base Services (RIBS) forces provide food service, billeting, recreation and fitness, troop issue (subsistence), field laundry, mortuary affairs, and operation of field exchanges in support of worldwide contingency operations.

1.8.5. **Chaplain Services.** A Chaplain Readiness Team (CRT) will normally deploy with the troops. The CRT is responsible for all religious activities, worship services, pastoral counseling, work area visitation, and pastoral and religious rites.

1.8.6. **Medical/Dental** support during deployments, if available, will be limited to stabilization of life threatening situations (prior to evacuation) and treatment of minor medical and surgical problems (i.e., colds, diarrhea, and minor cuts and bruises).



1.8.7. **Legal Services**, if available at all, will be limited. If a claims matter arises during your deployment, contact the judge advocate (JA) representative. If there is no JA representative, or if claims cannot be processed from your location, keep your repair receipts, photos, statements, etc., that substantiate your loss and file them with your claim after you return to home station. You have two years from the date of your loss to file a claim at any military claims office.

1.8.8. **Legal Defense Services** may or may not be available at your location. If you become the subject of an investigation, disciplinary action, or other adverse action, contact a defense counsel (DC) representative. If there is no DC representative at your location, contact the JA representative, your first sergeant, or commander to help you contact a DC.

1.8.9. **Communications**. Base communications services will vary considerably. Expect minimal services during the first weeks of a deployment (especially at a bare base) and improved services as the deployment matures and more capable communications equipment is installed.

1.8.10. **Supply**. Responsible for bulk storage of individual protective equipment, to include that received from the CMBCC, and issues replacement items to individuals or contamination control attendants.

## **CHAPTER 2 - PREPARING FOR HOSTILITIES**

This chapter outlines the rules of war all personnel must follow when deployed and explains actions you should take to minimize your vulnerability to an enemy attack and its effects. Although the use of chemical and biological weapons as a method of warfare is prohibited under international law, personnel must be prepared to respond to such an attack.

### **2.1. Law Of Armed Conflict (LOAC).**

The JA representative at your deployed location is the point of contact on armed conflict laws and engagement rules. If there is no JA representative at your location, your commander will assist you on these matters. LOAC is intended to keep the violence of war focused on defeating enemy forces, prevent needless destruction, and lessen civilian casualties.

**Note:** All US military personnel must obey the LOAC and have a duty to report LOAC violations. LOAC violations are punishable under the UCMJ.

### **2.2. Rules Of Engagement (ROE).**

Rules of engagement are directives specifying the circumstances and limitations under which US military forces will apply force. ROE are established for personnel safety and to ensure national policy and applicable laws are followed.

***ROE are lawful orders. ROE violations are punishable by UCMJ action and possibly under international law.***

### **2.3. The Code of Conduct.**

As a member of the US Armed Forces, you are protecting your nation. It is your duty to oppose all enemies of the United States whether in combat or as a captive in a prisoner of war (POW) facility. The Code of Conduct is a guide for your proper behavior. This code is the result of the heroic lives, experiences, and deeds of Americans from the Revolutionary War through our more recent conflicts.

2.3.1. ARTICLE I. I am an American, fighting in the forces which guard my country and our way of life. I am prepared to give my life in their defense.

2.3.2. ARTICLE II. I will never surrender of my own free will. If in command, I will never surrender the members of my command while they still have the means to resist.

2.3.3. ARTICLE III. If I am captured, I will continue to resist by all means available. I will make every effort to escape and aid others to escape. I will accept neither parole nor special favors from the enemy.

2.3.4. ARTICLE IV. If I become a prisoner of war, I will keep faith with my fellow prisoners. I will give no information or take part in any action which might be harmful to my comrades. If I

am senior, I will take command. If not, I will obey the lawful orders of those appointed over me and will back them up in every way.

2.3.5. ARTICLE V. When questioned, should I become a prisoner of war, I am required to give name, rank, service number, and date of birth. I will evade answering further questions to the utmost of my ability. I will make no oral or written statements disloyal to my country and its allies or harmful to their cause.

2.3.6. ARTICLE VI. I will never forget that I am an American, fighting for freedom, responsible for my actions, and dedicated to the principles which made my country free. I will trust in my God and in the United States of America.

#### **2.4. Threat Awareness.**

To ensure everyone at the deployed location is aware of the local threat situation, Security Forces will form a threat working group with representatives from organizations such as Intelligence, Civil Engineer, and the Air Force Office of Special Investigations (AFOSI). The installation commander (through the WOC or SRC) will notify you of actions to take in response to terrorist threats through threat conditions (ThreatCon).

2.4.1. **Individual Awareness.** Immediately report suspicious individuals and/or activities to either the AFOSI or security forces.

2.4.2. **ThreatCons** are standardized definitions and actions used to respond to terrorist threats against US personnel and facilities (See Table 2.1.). Your installation commander, with the advice of the Threat Working Group, will change the local ThreatCon in response to the threat of terrorist activity in your area.

TABLE 2.1. THREATCON DEFINITIONS AND ACTIONS		
	DEFINITION	ACTIONS
<b>N O R M A L</b>	A general threat of possible terrorist activity exists, but warrants only routine security measures.	<input checked="" type="checkbox"/> Routine security posture.
<b>A L P H A</b>	A general threat of possible terrorist activity against personnel and facilities exists, but nature and extent unpredictable.	<input checked="" type="checkbox"/> Secure unoccupied buildings, rooms, and storage areas. <input checked="" type="checkbox"/> Review plans for implementing higher THREATCONs. <input checked="" type="checkbox"/> Increase spot checks of personnel entering work centers and areas.
<b>B R A V O</b>	An increased and more predictable threat of terrorist activity exists.	<input checked="" type="checkbox"/> Complete all action of THREATCON <i>Alpha</i> . <input checked="" type="checkbox"/> At the beginning and end of each workday, and at other regular intervals, inspect the interior and exterior of buildings in regular use for suspicious packages. <input checked="" type="checkbox"/> Increase spot checks of personnel entering work centers. <input checked="" type="checkbox"/> Where possible, move vehicles, crates, and trash containers at least 25 meters from sensitive buildings (i.e., wing command post, control centers, group commander offices, etc.).

TABLE 2.1. THREATCON DEFINITIONS AND ACTIONS Continued.		
	DEFINITION	ACTIONS
C H A R L I E	An incident has occurred, or intelligence is received that indicates imminent terrorist acts against personnel and facilities.	<ul style="list-style-type: none"> <li><input checked="" type="checkbox"/> Complete all action of lower THREATCONS.</li> <li><input checked="" type="checkbox"/> Check ID of everyone entering work centers.</li> </ul>
D E L T A	A terrorist attack occurred or intelligence indicates that terrorist action against a specific location or person is likely.	<ul style="list-style-type: none"> <li><input checked="" type="checkbox"/> Complete all action of lower THREATCONS.</li> <li><input checked="" type="checkbox"/> Provide 24-hour-a-day owner/user security for controlled areas. Post personnel to conduct security checks and report to the law enforcement desk at least every 6 hours.</li> <li><input checked="" type="checkbox"/> Provide armed military escort in separate vehicles for all high risk items.</li> <li><input checked="" type="checkbox"/> Suspend nonessential commercial deliveries.</li> </ul>

**2.5. Passive Defense.**

Passive defense measures are actions taken to lessen damage to your installation from an enemy attack. Many passive defense measures are quick, inexpensive, and require minimal manpower and materials to implement.

2.5.1. **Hardening** includes all physical measures taken to prevent or reduce the loss of critical resources due to the destructive effects of conventional weapons. You may find the following types of hardened facilities at your deployed location:

2.5.1.1. **Fully hardened** protects a facility from the effects of direct hits from general purpose bombs, artillery shells, rockets, and mortars. Conventionally hardened facilities at your deployed location may include the wing operations center (WOC) and other key command and control facilities.

2.5.1.2. **Semi-hardened** facilities are protected from the effects of near misses, from general purpose bombs, and direct hits by artillery shells, rockets, and mortars. Semi-hardened facilities at your deployed location may include aircraft shelters and squadron operations buildings.

2.5.1.3. **Splinter protected** facilities are protected from weapons fragments, small arms fire, and magnification of blast pressure reflected from vertical surfaces. Most modern masonry buildings and expedient hardening methods (e.g., sandbags, earth berms, etc.) provide some splinter protection.

2.5.2. **Camouflage, Concealment, and Deception (CCD)** measures hide your base and its assets from enemy aircraft/forces or deceive them into attacking less valuable targets.

2.5.2.1. **Camouflage nets** come in several sizes and varieties to include radar scattering. The most important thing to remember when using camouflage nets is to break up the outlines of what you're trying to conceal.

2.5.2.2. **Tone down.** Painting can “tone down” an object to help it blend into the surrounding area. Vehicles, equipment, facilities, and even pavements can be camouflaged using this method. Painting has the advantage of being relatively fast and easy to accomplish, but has the drawback of being manpower intensive and requires periodic renewal when it starts to peel or fade.

**Tip:** Paint the tops of the buildings to mask patterns and distinct contours.

2.5.2.3. **Decoys** can be as simple as outlines on the ground or as complex as inflatable mockups that emit heat, and radar reflecting signatures of planes or vehicles.

2.5.3. **Dispersal** is spreading your equipment and people out over a wide area. You should disperse assets that cannot be sheltered (i.e., aircraft, vehicles, munitions, fuel bladders, etc.). Units should coordinate their dispersal plans so several units are not trying to use the same dispersal location or using locations that are potential target areas.



**Tip:** Establish priorities for dispersing assets. Give the highest priority assets the best protection. Do not cluster vehicles (private or government) near key facilities. Also consider power and communications requirements, access to assets, and availability of natural CCD.

2.5.4. **Blackout.** In an advanced state of readiness consider:

2.5.4.1. **Covering windows** with plywood, blankets, or whatever is available.

2.5.4.2. **Extinguishing outside lights.** Do not forget automatic battery powered lights that come on any time grid power is lost. Consider using chemical light sticks rather than flashlights.

2.5.4.3. **Making "cat eyes" for your vehicle lights.** These are cut-outs that leave an oblong opening for headlights. They provide enough light to drive, but not enough to be seen from a distance.

2.5.5. **Contamination Avoidance.** In the event of a chemical-biological attack, you can avoid extensive contamination and subsequent decontamination by implementing the following procedures:

2.5.5.1. Keep everyone under cover, when possible.

2.5.5.2. Keep vehicle windows rolled up and doors locked when unattended.

2.5.5.3. Ensure facility windows are closed and cracks are taped.

2.5.5.4. Ensure hatches on unsheltered aircraft are closed and sealed when possible.

2.5.5.5. Place as much equipment as possible indoors or under cover. If the equipment cannot be placed under cover, wrap or cover it with plastic sheets, canvas, tarpaulins, etc. Coverings should be changed after an attack to prevent agent penetration. Consider trying to double cover and remove the top cover after an attack. Your motto should be “If you’re not using it, cover it.”

**Tip:** Contamination control is greatly increased when equipment is covered with plastic. Items should be double wrapped (with plastic) whenever possible.

## **2.6. Air Base Defense (ABD).**

ABD forces must maintain a secure environment by detecting and engaging enemy forces that threaten sustained air operations. These forces must be organized to prevent and defeat attacks rather than to react passively.

2.6.1. Defending US Air Force resources is the responsibility of all air base personnel. US Air Force personnel who are armed and trained (for example, Prime BEEF, Prime RIBS, combat communications units, and selectively armed personnel) must take an active part in ABD. The commander at each base must carefully consider selective arming and augmentation programs. If the threat requires more armed personnel than are already in place, commanders must plan for reinforcements.

### **2.7. Attack Alarm Signals.**

To help keep you informed on current enemy attack threat and status, the installation commander (through the SRC) will use attack alarm signals. The standardized alarm signals for areas subject to NBCC attack are *All Clear*, *Alarm Yellow*, *Alarm Red*, and *Alarm Black*. These signals are conveyed through warning systems such as Giant Voice, flags, placards, lights, sirens, etc. Most installations have certain local procedures. See Chapter 4 for more detailed after attack information.

**Figure 2.1. USAF Standardized Alarm Signals.**

<b>USAF STANDARDIZED ALARM SIGNALS</b> FOR AREAS SUBJECT TO NBCC ATTACK		
IF YOU	FOR A CONVENTIONAL PROTECTIVE POSTURE YOU MUST	FOR A CHEMICAL/ BIOLOGICAL PROTECTIVE POSTURE YOU MUST
<b>Hear: "Alarm Yellow"</b>  See: A Yellow Flag	Attack is probable (pre-attack) Don helmet and available body armor Go to shelter when directed	Attack is probable (pre-attack) Don helmet and available body armor Go to shelter or seek overhead protection when directed Assume MOPP 1 unless otherwise directed
<b>Hear: "Alarm Red"</b>  See: A Red Flag	Attack is imminent or in progress (Trans-Attack)  Take cover	Attack is imminent or in progress (Trans-Attack) Take cover Assume MOPP 4 unless otherwise directed
<b>Hear: "Alarm Black"</b>  See: A Black Flag	Attack is over (Post-Attack) Go to or stay in shelter unless otherwise directed  Initiate post attack reconnaissance	NBC contamination is expected or present (Post-Attack) Go to or stay in shelter unless otherwise directed Initiate post attack reconnaissance Assume MOPP 4 unless otherwise directed
<b>Hear "All Clear"</b>	Attack is not probable, nor is NBC contamination present Resume normal operations or initiate recovery if applicable	Attack is not probable, nor is NBC contamination present Resume normal operations or initiate recovery if applicable
<b>Local Information:</b>		

**2.8. Mission-Oriented Protective Posture (MOPP).**

MOPP levels allow commanders to authorize various standard options for wearing the GCE depending on the threat, heat stress, and mission urgency. See Figure 2.2. through 2.4. for a description of MOPP levels.

Figure 2.2. MOPP 0 and 1.

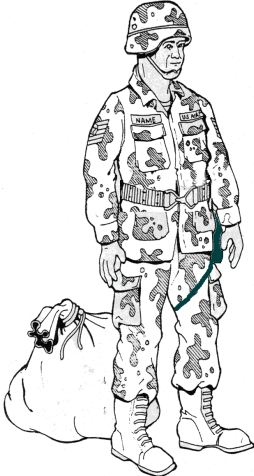

	
<p align="center"><b>MOPP LEVEL 0</b> <b>WORN</b></p>	<p align="center"><b>MOPP LEVEL 1</b> <b>WORN</b></p>
<p>◆ MASK CARRIER      ◆ FIELD<sup>2,3</sup> GEAR</p>	<p>◆ OVERGARMENT      ◆ FIELD GEAR ◆ MASK CARRIER</p>
<p align="center"><b>AVAILABLE</b></p>	<p align="center"><b>CARRIED</b></p>
<p>TYPE ISSUED, PREPARED, AVAILABLE WITHIN 5</p>	<p>FOOTWEAR COVERS MASK/HOOD GLOVES</p>
<p align="center"><b>PRIMARY USE</b></p>	<p align="center"><b>PRIMARY USE</b></p>
<p align="center">CB THREAT PRE-ATTACK</p>	<p align="center">CB THREAT PRE-ATTACK</p>
<p>◆ During Periods of Increased Alert When Enemy has Chemical Biological Employment Capability, but There is No Indication of Use in the Immediate Future.</p>	<p>◆ CHEMICAL BIOLOGICAL ATTACK IN THEATER IS POSSIBLE</p>

Figure 2.3. MOPP 2 and 3.



	
<b>MOPP LEVEL 2</b>	<b>MOPP LEVEL 3</b>
<b>WORN</b>	<b>WORN</b>
♦ OVERGARMENT ♦ FIELD GEAR <sup>2</sup> ♦ MASK CARRIER ♦ FOOTWEAR COVERS	♦ OVERGARMENT ♦ FIELD GEAR <sup>2</sup> ♦ MASK CARRIER ♦ FOOTWEAR COVERS
<b>CARRIED <sup>3</sup></b>	<b>CARRIED <sup>3</sup></b>
MASK/HOOD GLOVES	GLOVES
<b>PRIMARY USE</b>	<b>PRIMARY USE</b>
CB THREAT PRE-ATTACK	CB THREAT TRANS/POST ATTACK
♦ CHEMICAL BIOLOGICAL ATTACK IN THEATER IS PROBABLE	♦ IN AREAS WITH NEGLIGIBLE CONTACT HAZARD

Figure 2.4. MOPP 4 and ALPHA.



	
<b>MOPP LEVEL 4</b>	<b>MOPP LEVEL ALPHA</b>
<b>WORN</b>	<b>WORN</b>
<ul style="list-style-type: none"> <li>◆ OVERGARMENT</li> <li>◆ MASK CARRIER</li> <li>◆ FIELD GEAR<sup>2</sup></li> <li>◆ FOOTWEAR COVERS</li> </ul>	<ul style="list-style-type: none"> <li>◆ MASK/HOOD</li> <li>◆ FIELD GEAR</li> <li>◆ GLOVES</li> </ul>
<b>CARRIED<sup>3</sup></b>	<b>CARRIED<sup>3</sup></b>
	OVERGARMENT FOOTWEAR COVERS
<b>PRIMARY USE</b>	<b>LIKELY USE</b>
CB THREAT TRANS/POST ATTACK	CB THREAT TRANS/POST ATTACK
<ul style="list-style-type: none"> <li>◆ WHEN THE HIGHEST DEGREE OF CB PROTECTION IS REQUIRED</li> <li>◆ WHEN PERSISTENT CHEMICAL AGENTS ARE PRESENT</li> <li>◆ WHEN CB AGENTS ARE PRESENT; THE ACTUAL HAZARD HAS NOT BEEN DETERMINED</li> </ul>	<ul style="list-style-type: none"> <li>◆ UPWIND FROM A NEGLIGIBLE CHEMICAL VAPOR HAZARD AGENT</li> <li>◆ BIOLOGICAL WARFARE AGENTS ARE BEING EMPLOYED</li> <li>◆ INSIDE VEHICLES, BUILDINGS OR AIRCRAFT</li> <li>◆ UNDER NUCLEAR FALLOUT CONDITIONS</li> </ul>



TABLE 2.2. MOPP NOTES & OPTIONS	
<p>NOTES:</p> <ol style="list-style-type: none"> <li>1. Field Gear consists of helmet, web belt, canteen, and, if issued, body armor (WORN OVER THE OVERGARMENT).</li> <li>2. Carry or keep at hand protective equipment such as M8/M9 paper, Nerve agent antidotes, and decontamination kits.</li> <li>3. If "All Clear, MOPP 0" is announced, web belt and canteen may be worn if desired.</li> <li>4. Only the installation commander directs the MOPP levels and variations listed above. Modifications to MOPPs and variations must be approved by MAJCOM or Theater commander.</li> </ol>	
OPTION	PROCEDURES/IMPACTS
<b>Mask Only</b>	<p><b>Mask-Only:</b> The mask, hood, and long sleeve duty uniform (for limited skin protection) may be worn.</p> <p><b>Note:</b> Since some blood and nerve agent vapors are absorbed through the skin, the possibility of incapacitating concentration, while low, exists.</p>
<b>No-BDUs</b>	<p><b>No BDUs:</b> Individuals, when directed, wear the overgarment over underwear when heat stress is expected to be a significant factor</p> <p><b>Note:</b> Since this variation increases the risk of skin contamination, do not use it unless absolutely necessary for mission accomplishment.</p>
<b>Ventilation</b>	<p><b>Ventilation - Open Overgarment:</b> In some cases, personnel may, with little risk, open the overgarment jacket to aid ventilation and reduce thermal build-up.</p> <p><b>This variation is automatically revoked with each MOPP level increase, unless specifically reauthorized by the commander.</b></p> <p>Once MOPP 3 or 4 is declared the jacket must be zipped up.</p>

### **CHAPTER 3 - WHAT TO DO IF THERE IS AN ATTACK**

This chapter explains actions you should take to report an attack you witness and to shelter yourself from its effects.

#### **3.1. Report the Attack.**

You may be the first to realize you are under attack. Report any attack you witness. (See paragraph 4.3.)

***Do not wait until Alarm Black to report information if you have the means to report it without endangering yourself.***

#### **3.2. Seek Cover.**

During a conventional attack, the greatest danger is from shrapnel and other debris. You should always be aware of the nearest overhead cover and/or protective bunker so you will not spend time searching for it during an attack. Upon warning of an impending attack, get to the best cover immediately, keeping in mind the following:

3.2.1. On open ground, lying flat (face down) reduces exposure to shrapnel and blast effects. Time permitting, seek a protective shelter with overhead protection.

3.2.2. Any building, sandbagged bunker, or tent is better protection than lying on the open ground. Don't stay in a low lying area any longer than necessary – chemical agent vapors migrate to, and remain in low-lying areas.

3.2.3. Below ground-level shelter (a ditch or foxhole) provides still better protection.

3.2.4. The center of the lowest floor provides the best protection inside a building.

3.2.5. Avoid taking shelter near or under aircraft or vehicles, as they are potential targets. Additionally, pilots/vehicle operators may move the aircraft/vehicles while you are still under attack.

3.2.6. Collective protection provides a toxic-free environment that allows personnel to obtain rest and relief (long-term or short-term) or perform special functions (command and control, medical treatment) without the encumbrance of IPE. Collective protection (ColPro) systems protect those inside a building, room, shelter or tent against contamination through the combination of impermeable structural materials, air filtration equipment, air locks, and overpressurization. ColPro systems reduce contamination levels when personnel enter or exit the structure. If ColPro systems are not available and NBC contamination is present and persists beyond a few hours, it may become necessary to locate and designate contamination-free areas for rest and relief.

## CHAPTER 4 - BASE RECOVERY AFTER ATTACK

This chapter explains immediate Base Recovery After Attack (BRAAT) actions you should take after an attack and how you should report the attack.

### 4.1. After An Attack.

Determine the Alarm Condition, MOPP level, and ThreatCon. (See Figure 2.1. for standard alarm conditions, 2.2 through 2.4 for MOPP levels, and Table 2.1. for ThreatCons).

4.1.1. If the condition is *All Clear, Alarm Yellow*, you may cautiously venture out to gather information on the effects of the attack and start recovery.

4.1.2. If the condition is *Alarm Red* stay in your protective area unless you have critical mission essential duties or unless directed to do so by an appropriate authority.

4.1.3. If the condition is *Alarm Black*, mission essential personnel and those designated to conduct initial reconnaissance may cautiously venture out to gather information on the effects of the attack and start recovery. If you don't have a reason to be outside, stay put until the SRC makes a base assessment of the hazards.

4.1.3.1. You must determine if you are in a conventional or NBC threat area and take appropriate actions in *Alarm Black*. *Alarm Black* in a conventional threat area is a time for trained teams and individuals to search for UXO, casualties, and assess damage.

4.1.3.2. When NBC contamination is suspected or present, additional contamination avoidance procedures must be followed. Realize that some mission critical activities such as generating sorties must continue even in *Alarm Black*. Use caution when allowing individuals into your shelter during a NBC *Alarm Black*. Until reconnaissance actions are complete and *Alarm Yellow* or *All Clear* signals are announced, use caution when allowing anyone into your shelter--they may be contaminated.

## **4.2. Recovery from an Attack.**

Everyone must work together to recover from an attack and reposition for subsequent attacks. Immediate actions are necessary to treat casualties and respond to hazards such as contamination, damage/fire, unexploded ordnance, etc.

4.2.1. Treat Casualties. Practice self-aid and buddy care Chapter 10. Get injured people to a casualty collection point as soon as possible (it is up to your unit to transport casualties). If chemical agent exposure is evident, use the nerve agent antidotes, if appropriate (See paragraph 5.3.) and/or the skin decontamination kit (See paragraph 5.5.) The appropriate

MOPP gear must be worn when handling or treating a contaminated casualty.

4.2.2. Damage. Work centers should be surveyed to determine the extent of damage to aircraft, facilities, vehicles, and equipment. Relocation may be necessary. If there is a fire, your involvement in fighting a fire is limited. After notifying the fire department and evacuating the facility, you should initiate "limited" fire fighting procedures. (See Chapter 11)

4.2.3. Contamination. Avoid contact with objects and areas that may be contaminated. If the mission permits, decontaminate areas that you must touch to perform your mission (e.g., maintenance panels, door handles, steps, etc.). See Tables 4.4. and 5.7. for decontamination levels and methods.

### **4.3. Post-Attack Reporting.**

Report as much about the attack as possible. Use report checklists in Table 4.2. to help gather information described in paragraph 4.3.1. Report the information to your control center using the fastest means available (telephones, radios, hot lines, or runners).

#### **4.3.1. What to Report:**

4.3.1.1. Observations of the attack.

4.3.1.2. Types of weapons systems and munitions used (aircraft, missiles, rockets, mortar, etc.).

4.3.1.3. Tactics used (direction of origin, strength, ground forces).

4.3.1.4. Explosions you heard or felt.

4.3.1.5. Damage to mission essential equipment, aircraft, facilities, parking ramps, taxiways, runways, etc.

***Reporting the absence of damage is just as important; this lets control centers know what has already been checked.***

4.3.1.6. Casualties and missing persons.

4.3.1.7. Contamination (and evidence of suspected contamination). Concentrate on what changes occurred as a result of the attack (i.e. change in M8/M9 paper, a surface is wet that wasn't wet before, a thin film of dust is covering the area, etc.) See Chapter 5 for more indicators of a chemical attack.

4.3.1.8. Unexploded Ordnance (UXO) (locations, types, and sizes). Also include information on established cordons.

#### **4.4. "BRAAT Kit".**

As a minimum, control centers, shelters, and other occupied facilities should consider having a BRAAT kit available to whoever is designated to perform the initial post-attack reconnaissance. The kit, whether it be a tool bag or whatever is available should at least contain:

- 4.4.1. Basic first aid supplies.
- 4.4.2. Standard markers for NBC contamination and UXO.
- 4.4.3. Resources to mark damage, contamination, or UXO at night such as flashlights or “chem sticks”.
- 4.4.4. Available assets for detection such as M8 or M9 paper and possibly M256 kits for chemical detection.
- 4.4.5. Checklists showing where to look, what to look for, priorities, etc.



<b>TABLE 4.1. POST-ATTACK DAMAGE &amp; CASUALTY CHECKLIST ITEMS.</b>	
<b>1. Call your unit control center or survival recovery center to report</b>	
<input checked="" type="checkbox"/>	Name/Rank
<input checked="" type="checkbox"/>	Unit
<input checked="" type="checkbox"/>	Phone/Radio Net
<input checked="" type="checkbox"/>	Date/Time
<b>2. Report the location of the incident</b>	
<input checked="" type="checkbox"/>	(Facility/grid coordinates/other information)
<b>3. Report any damage</b>	
<input checked="" type="checkbox"/>	(Condition of area/facility/equipment)
<b>4. Report the status of casualties</b>	
<input checked="" type="checkbox"/>	Number Dead
<input checked="" type="checkbox"/>	Number Injured
<input checked="" type="checkbox"/>	Number Missing
Report their disposition	
<input checked="" type="checkbox"/>	Evacuated to CCP
<input checked="" type="checkbox"/>	Applied First-Aid
<input checked="" type="checkbox"/>	Awaiting Transport
<input checked="" type="checkbox"/>	Etc

#### **4.5. Explosive Ordnance Reconnaissance (EOR).**

UXO are hazards – whether on the battlefield or in designated impact areas. UXO includes ordnance items that have been fired, projected, dropped, or placed in such a way that they could become armed and go off.

4.5.1. UXO can be conventional, chemical, biological, or any combination thereof. Whether in an area by design or accident, these items have not yet functioned. Whatever the reason, UXO poses a risk of injury or death to all personnel. UXO can be missiles, bombs, rockets, mines, or other devices and can range in size from very small to large objects. UXO may have malfunctioned or they may be operating as designed. Some are designed to explode after a preset time and others explode if touched or jarred.

4.5.2. UXO can kill or injure anyone who comes in contact with them, by accident or as intended. It is your responsibility to understand and execute explosive ordnance reconnaissance.

4.5.3. The EOR process allows the Explosive Ordnance Disposal (EOD) teams to track, prioritize, respond to, and safe the UXO. EOR involves three steps: **IDENTIFY, MARK, AND REPORT**. If you find a UXO or suspect an object is one:

4.5.3.1. Recognize the UXO hazard.

4.5.3.2. Take immediate action (mark and evacuate).

4.5.3.3. Report the UXO hazard.

4.5.3.4. Use protective measures against the UXO hazard, if required.

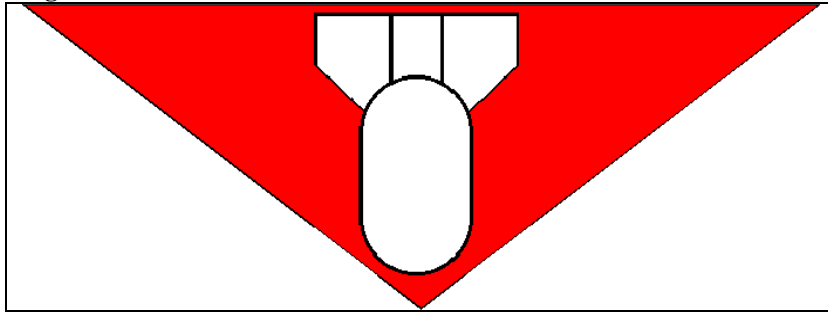
4.5.3.5. DO NOT TOUCH IT!

4.5.3.6. Do not move closer to it.

4.5.3.7. Do not try to remove anything that is on or near a UXO and never attempt to remove any part of a UXO.

4.5.3.8. Mark it from where you are (use whatever material is available--but make sure the marker is visible from all directions and at night). Figure 4.1. illustrate a standard marker.

**Figure 4.1. Standard UXO Marker.**



4.5.3.9. Use protective measures to include evacuation, isolation, and barricades.

4.5.3.9.1. Evacuation. Evacuate the area around the UXO to a safe distance based upon local instructions and the size and type of ordnance.

4.5.3.9.2. Isolation. Sometimes, for mission-related, operational, or other reasons, you cannot evacuate personnel and/or equipment or you can not leave a particular area. When this happens, you must isolate either your assets (personnel, equipment, and operations) from the UXO or isolate the UXO from your assets.

4.5.3.9.3. Barricades. Personnel and equipment that cannot be moved must be protected with barricades. A barricade is an artificial barrier that provides limited protection by channeling the blast and fragmentation away from the threatened area.

4.5.3.10. Report it by class and number (i.e. F5 or "Foxtrot 5 would be a grenade. The class would be Rocket Propelled Grenades and Grenades - the "5" corresponds to the number on the chart). Report shape, color, size, etc. if you can not recognize it by using the UXO Identification Guide - it may be an improvised explosive device (IED). See Table 4.2. and the UXO Identification Guide (Table 4.3.) for more information.

**Warning:** Make all radio transmissions at least 25 meters away from a UXO hazard.

**Warning:** DO NOT collect UXO as "souvenirs."

<b>TABLE 4.2. UNEXPLODED ORDNANCE (UXO) CHECKLIST ITEMS</b>
<b>1. Call your unit control center or survival recovery center to report</b>
<input checked="" type="checkbox"/> Name/Rank <input checked="" type="checkbox"/> Unit <input checked="" type="checkbox"/> Phone/Radio Net <input checked="" type="checkbox"/> Date/Time
<b>2. Report the location and cordon size of the UXO</b>
<input checked="" type="checkbox"/> (Bldg number, grid coordinate, distance from a landmark or bldg, etc.) Explain how the UXO is marked and the distance between the UXO and marker.
<b>3. Report the "Class" or shape (i.e. "Bravo 1" UXO)</b>
<input checked="" type="checkbox"/> (See Table 4.3., UXO Identification Guide)
<b>4. Report any identifying features</b>
<input checked="" type="checkbox"/> For example the color, size, length, and markings
<b>5. Report the condition of the UXO</b>
<input checked="" type="checkbox"/> Is it leaking? <input checked="" type="checkbox"/> Is it intact? <input checked="" type="checkbox"/> Is it broken? <input checked="" type="checkbox"/> Etc.
<b>6. Report any other significant information</b>



TABLE 4.3. UXO IDENTIFICATION GUIDE	
BOMBS AND DISPENSERS	
Class A	
	<p><b>Bomb</b></p>
	<p><b>Bomb</b></p>



TABLE 4.3. UXO IDENTIFICATION GUIDE Continued	
BOMBS AND DISPENSERS	
Class A	
	
	<b>Bomb</b>
	
	<b>Dispensers</b>


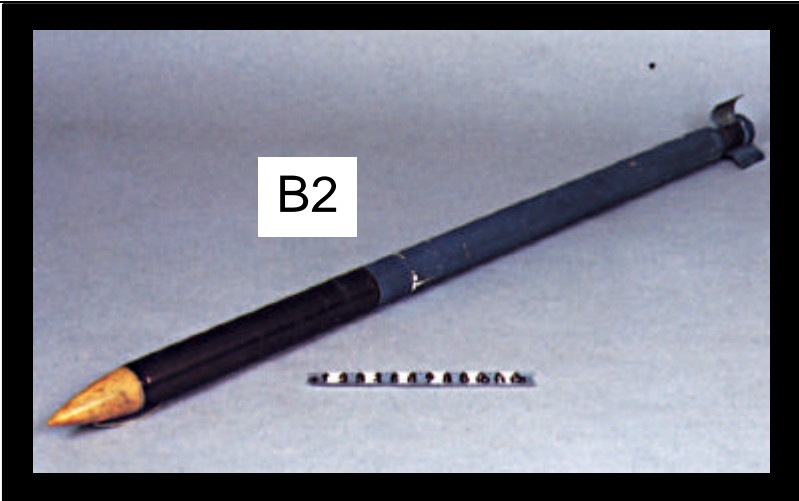
TABLE 4.3. UXO IDENTIFICATION GUIDE Continued	
ROCKETS AND MISSILES	
Class B	
	
<b>Missile</b>	
	
<b>Rocket</b>	






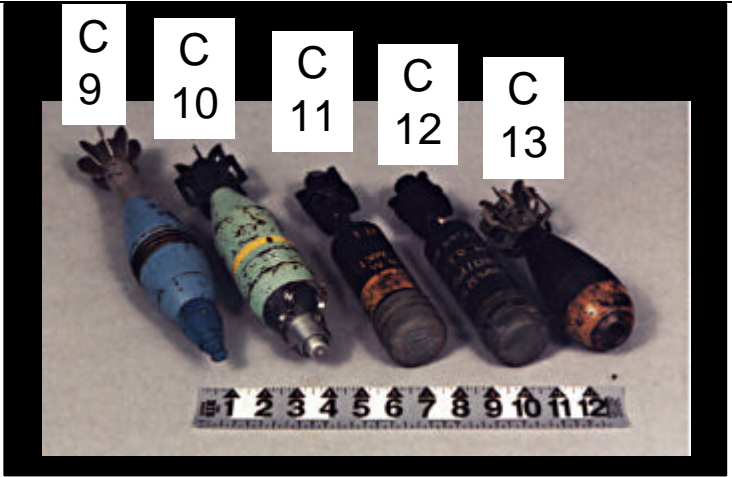
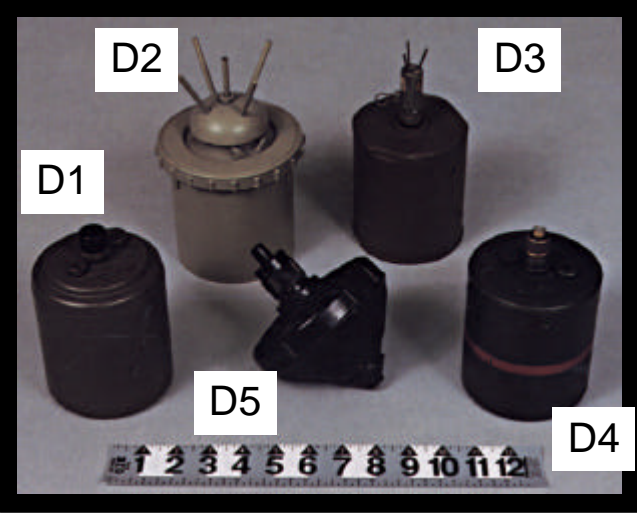

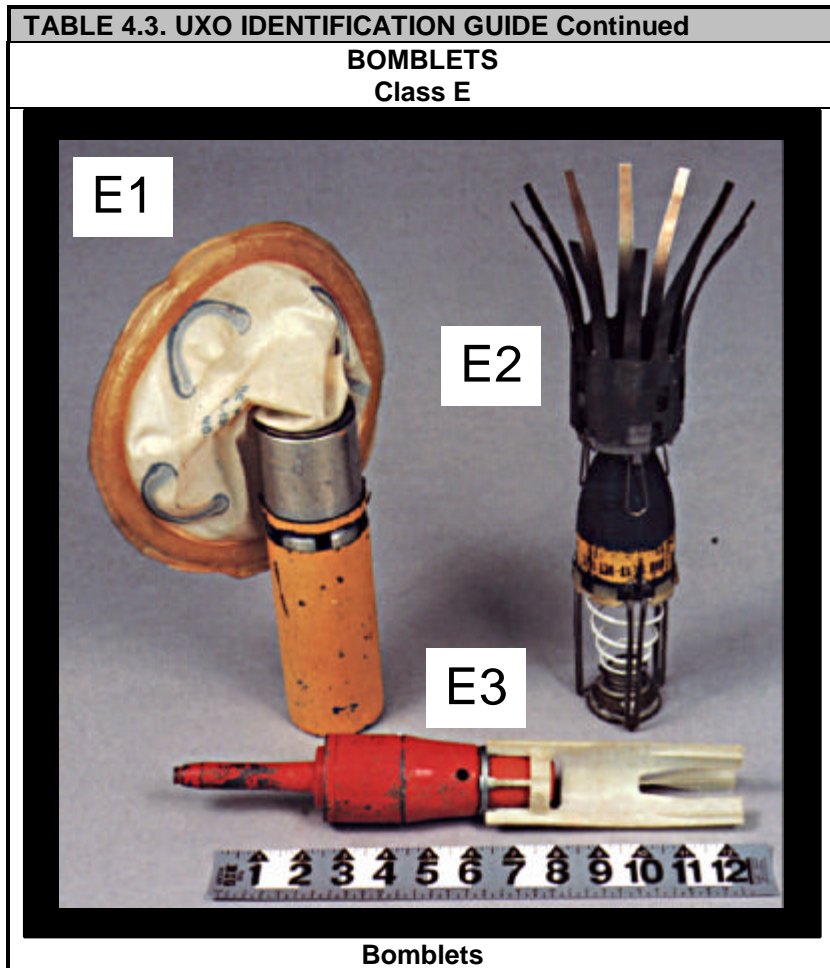
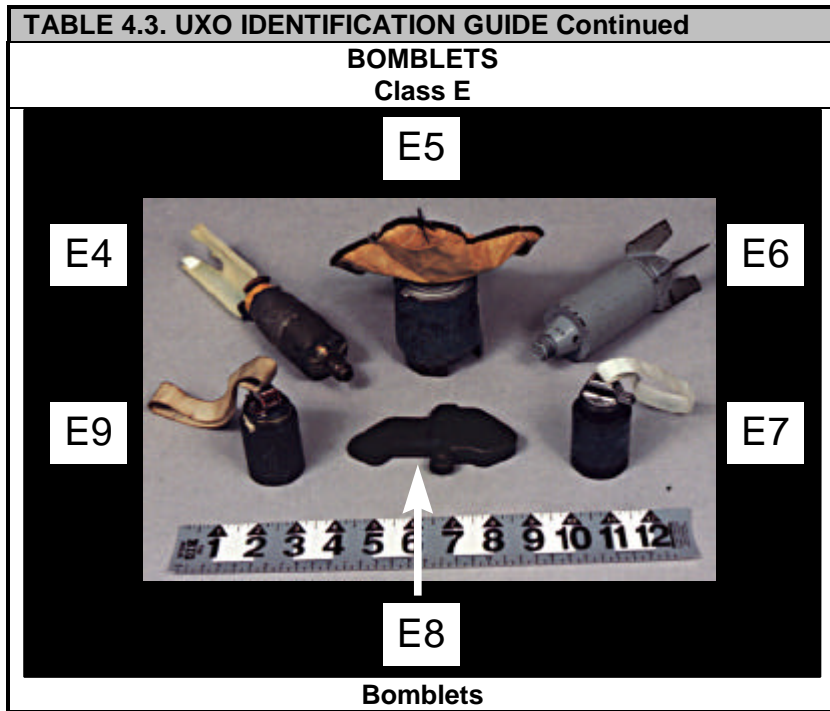
TABLE 4.3. UXO IDENTIFICATION GUIDE Continued	
PROJECTILES AND MORTARS	
Class C	
	<p>C6</p> <p>C7</p> <p>C8</p>
Projectiles	
	<p>C9</p> <p>C10</p> <p>C11</p> <p>C12</p> <p>C13</p>
Mortars	

TABLE 4.3. UXO IDENTIFICATION GUIDE Continued	
<b>LANDMINES</b> Class D	
 <p>D1 D2 D3 D4 D5</p> <p>↑ 1 2 3 4 5 6 7 8 9 10 11 12</p> <p>Landmines</p>	
 <p>D5 D6</p> <p>↑ 1 2 3 4 5 6 7 8 9 10 11 12</p> <p>Landmines</p>	





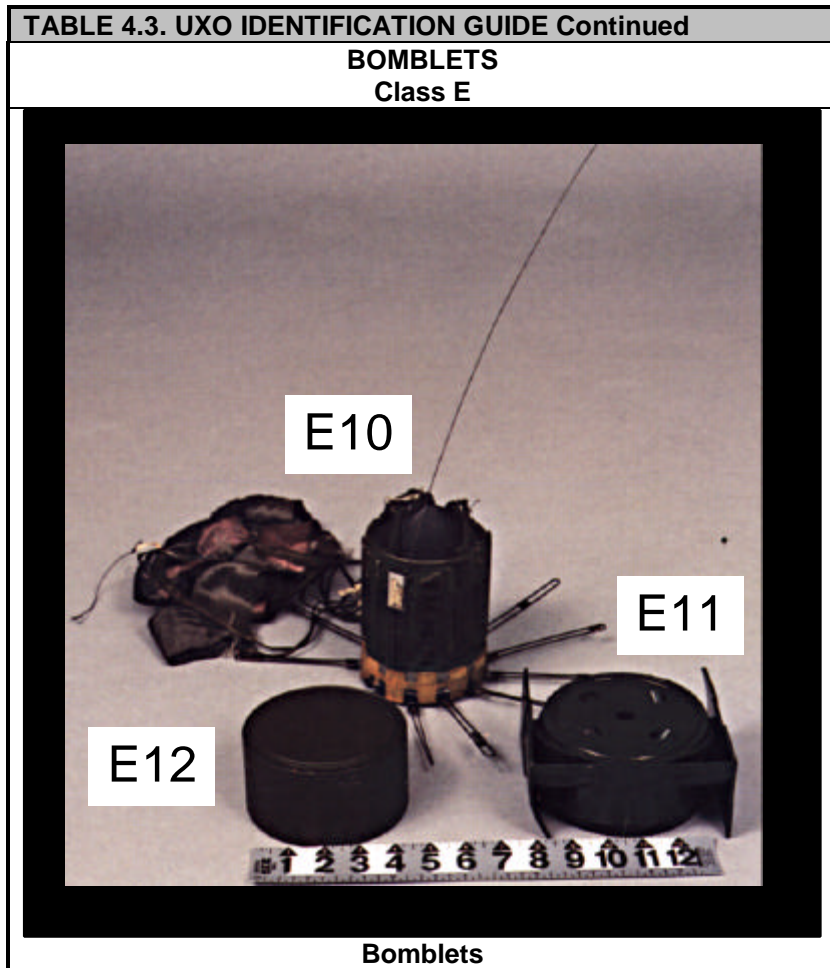

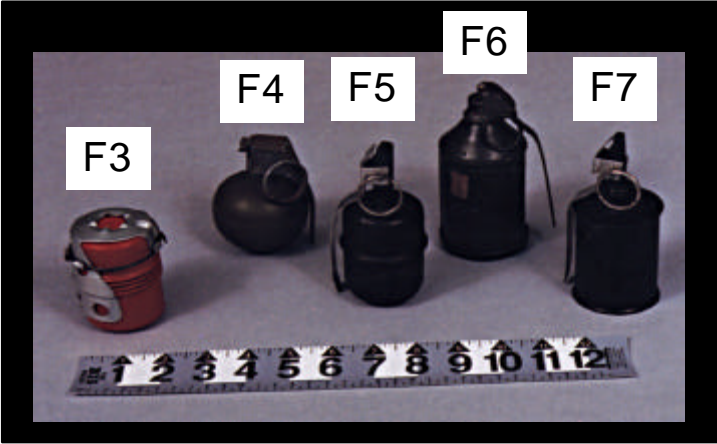


TABLE 4.3. UXO IDENTIFICATION GUIDE Continued	
ROCKET PROPELLED GRENADES AND GRENADES	
Class F	
	
RPGs	
	
GRENADES	

#### **4.6. Decontamination.**

CB agent decontamination is required immediately if skin contact occurs with agents in liquid or solid form. Personnel or equipment inside an undamaged facility or under another form of cover will not require decontamination, providing contamination is not transferred inside. Decontamination is performed at four levels: immediate, operational, thorough, and reconstitution. Base populace primarily operates at the first two levels: immediate and operational. Table 4.4. explains the different levels. Decontamination of personnel is accomplished by processing through a contamination control area (CCA).



<b>TABLE 4.4. DECONTAMINATION LEVELS.</b>	
<b>IMMEDIATE</b>	
Aim	Minimize casualties, save lives, limit the spread of contamination.
Who	Individual. Use the buddy system.
What	Skin, personal clothing, and equipment. If eyes were exposed, flush with water from canteen. Use the M258A1, M291, or M295 kit for skin and equipment.
When	As soon as contamination is suspected.
<b>OPERATIONAL</b>	
Aim	Minimize contact or transfer hazard and sustain operations.
Who	Individuals, crews, teams, units.
What	Decontaminate only those parts/areas that you must come in contact with to perform your mission. (maintenance panels, door handles, steps, etc.). Weathering and aeration are viable decontamination alternatives.
When	Conducted when operations require.
<b>THOROUGH</b>	
Aim	Reduce contamination to lowest possible level.
Who	Units or wings, with or without external support and specially trained teams.
What	Personnel, equipment, material or work areas.
When	When operations, manning, and resources permit.
<b>RECONSTITUTION</b>	
Aim	Eliminate contamination to restore mission critical resources permitting unrestricted use.
Who	Units or wings with external support and specially trained teams.
What	Mission critical aircraft, equipment, material, work areas, and terrain.
When	After hostile actions have terminated or directed by higher authority.

#### **4.7. Contamination Control Area (CCAs).**

CCAs are essential to sustained operations in a CB environment. They provide controlled entry areas, force personnel to practice effective contamination avoidance procedures, and limit the spread of contamination into toxic free areas (TFAs). TFAs provide personnel the ability to work or obtain rest and relief without wearing IPE. The hostile use of chemical agents against USAF operating locations will almost certainly force the creation of CCAs, regardless of the agent or external factors involved. One or both of the following situations will likely occur after the attack.

4.7.1. If an air base is attacked with chemical agents, the persistency of the agents may necessitate MOPP gear wear for extensive periods of time. Consequently, the work force will require some form of rest and relief shelter in order to sustain mission operations. Rest and relief will primarily be accomplished by processing people through a CCA into a TFA.

4.7.2. A very small percentage of the base population will have their chemical protective clothing contaminated at the time of the attack because they could not find adequate overhead protection. Still others will contaminate their protective clothing during post-attack operations. This contaminated clothing must be removed as soon as possible but absolutely within 24 hours. The exchange of contaminated clothing for clean protective clothing will take place at the CCA. A small delay before processing personnel into the CCA allows the suits to aerate and reduce cross-contamination hazards in the CCA.

4.7.3. Each CCA will have an entrance, contact hazard area (CHA), vapor hazard area (VHA), and an airlock. In open air configurations, the airlock is a designated transition area between the VHA and the TFA. The CCA/TFA complex is composed of the following sub-elements.

4.7.3.1. Transportation drop off point. It is in this area that the first active efforts are taken in reducing both the contact and vapor hazards.

4.7.3.2. Entrance and Holding area. This area is used to inform personnel of the sequence of events, and any emergency response procedures. It also provides a covered area for rest while waiting to process.

4.7.3.3. Contact Hazard Area (CHA). In this area personnel will remove the majority of their individual protective equipment following step by step procedures. The goals of the CHA are contamination reduction in regards to processing personnel and the containment of all contact hazards. The following are major sub-elements of the CHA:

4.7.3.3.1. Overgarment Aeration / Laundry Area. If the threat of multiple chemical attacks is probable, suits are in short supply, or there isn't a realistic resupply capability, then an aeration area is critical to mission sustainment.

4.7.3.3.2. Contaminated Waste Disposal Area.

4.7.3.4. Vapor Hazard Area (VHA). The VHA provides the last chance for the CCA staff to verify processing personnel are free of any type of contamination before the individual(s) transition to the TFA.

4.7.3.5. Mask Decontamination and Refurbishment Area. In this area individual protective masks will be decontaminated, refurbished, and stored for re-issue.

4.7.3.6. Transition Buffer Zone Between CCA and TFA. This area provides a buffer zone to prevent vapors from reaching the TFA.

4.7.3.7. Toxic Free Area. A clean environment for personnel to rest and recuperate. This area can be on or off the base proper.



## **CHAPTER 5 - CHEMICAL WARFARE DEFENSE**

This chapter provides a summary of chemical warfare (CW) threats and defensive actions.

### **5.1. Threat.**

CW agents having military significance are categorized as nerve, blister, blood, or choking agents with nerve and blister agents being the most likely to be used against air bases. The most serious threat of an enemy attack on our air bases using CW agents is from tactical ballistic missiles (TBMs) and aerial-delivery bombs using agents in vapor, aerosol, solid (dusty), liquid form or any combination. See Tables 5.1. through 5.5. for a complete breakout of CW agents, their hazards, symptoms, and treatment.

### **5.2. Chemical Agents.**

Chemical agents maim, kill, seriously injure, or incapacitate unprotected people. These agents include blood, nerve, choking, blister, and incapacitating agents. Threats to Air Force operations revolve primarily around the persistent nerve and blister agents. Chemical agents are classified according to physical state, physiological action, and use. The terms persistent and nonpersistent describe the time chemical agents remain a threat in a targeted area.

5.2.1. Chemical agents may exist as solids, liquids, or gases. To a certain extent the state in which an agent exists determines its

use, duration, effectiveness, and physiological action. The physical state of an agent also contributes to a determination on munitions delivery vehicle and methods used for its dissemination.

5.2.1.1. **Vapor and aerosol agents** dissipate within hours rather than days, allowing the enemy to quickly use captured areas and equipment.

5.2.1.2. **Solid and liquid agents may persist** for hours, days, or months depending on the agent, weather conditions, and other factors, making them well suited for slowing down an enemy's operations. Therefore, you should plan to work in a chemical environment while wearing protective gear for an extended period of time. You may receive rest and relief in collective protection facilities or at designated toxic-free areas.

<b>TABLE 5.1. CHEMICAL WARFARE (CW) AGENT HAZARDS.</b>	
<b>FACTOR</b>	<b>INFLUENCE</b>
How you can be exposed	Through breathing (inhalation), the skin, and the eyes. Drink and food contaminated by CW agents are harmful. Other means of exposure are breaching of the full protective ensemble (i.e., from a tear caused by a munitions fragment) and transfer from a contaminated surface during processing through a Contamination Control Area (CCA) or Aircrew Contamination Control Area (ACCA).
Persistency	The persistency, or duration, of CW agent hazards ranges from a few seconds to months. The most important factor affecting persistency are specific agent characteristics and weather. Additional factors affecting persistency are method of agent dissemination, droplet size, characteristics of contaminated surfaces and terrain.
Effects of Weather	Weather factors include temperature, wind, humidity, precipitation, and atmospheric stability. High winds and heavy rains help to reduce the contamination hazard. Lack of wind, overcast skies, and moderate temperatures favor persistence.
Effects of Surface and Terrain	CW agent clouds tend to follow the terrain, flowing over rolling countryside and down valleys. Hazardous amounts may persist in hollows, depressions, and other areas of low ground. Rough terrain, such as forest areas, retards cloud movement. Flat countryside allows a uniform, unbroken cloud movement. Vegetated areas are more easily contaminated than barren terrain because the vegetation picks up the agent. Liquid agents will soak into porous surfaces, making evaporation slower than non-porous surfaces.

TABLE 5.2. NERVE AGENT SYMPTOMS & PROTECTION		
CHARACTERISTICS	SYMPTOMS	PROTECTION
<ul style="list-style-type: none"> <li>- May have a fruity smell or camphor odor.</li> <li>- Most lethal of all agents.</li> <li>- Immediate symptoms, lethal within minutes.</li> <li>- Affects nervous system.</li> <li>- May be inhaled, ingested, or absorbed through the skin.</li> <li>- In vapor, solid, or liquid form.</li> <li>- Persistency can range from minutes to many days, depending on weather conditions and the agent.</li> <li>- Antidotes may be effective even if given to a victim having advanced symptoms, as long as the victim continues to breathe.</li> </ul>	Pinpointing of pupils.	<input checked="" type="checkbox"/> Take pretreatment tablets as directed.
	Muscular twitching. Dimness of vision. Runny nose.	<input checked="" type="checkbox"/> Wear full protective ensemble as directed.
	Tightness of chest. Difficulty in breathing.	<input checked="" type="checkbox"/> Avoid overgarment saturation by practicing contamination avoidance and expedient decontamination.
	Excessive sweating. Drooling, nausea, vomiting.	
	Involuntary urination and defecation.	<input checked="" type="checkbox"/> Use auto-injectors when experiencing symptoms.
	Convulsions, coma, death.	<input checked="" type="checkbox"/> Flush eyes and open wounds with water and protect from further contamination.
	Intermittent, cumulative exposures to very low amounts can lead to the same ultimate effect as a single exposure to a higher amount.	<input checked="" type="checkbox"/> Use decontamination kits to neutralize agents on skin.  <input checked="" type="checkbox"/> Seek medical attention as soon as possible after any exposure or as soon as symptoms appear



<b>TABLE 5.3. BLISTER AGENT SYMPTOMS &amp; PROTECTION</b>		
<b>CHARACTERISTICS</b>	<b>SYMPTOMS</b>	<b>PROTECTION</b>
<ul style="list-style-type: none"> <li>- Some also known as mustard agents.</li> <li>- May smell like garlic or have a fishy/musty odor.</li> <li>- Damages blood, liver, and kidneys.</li> <li>- Employed as vapors, liquids, or solids.</li> <li>- Causes blisters, destroys tissues, injures blood vessels.</li> <li>- Some will violently irritate mucous membranes of eyes and nose.</li> <li>- Affects eyes, respiratory system, skin.</li> <li>- May be lethal if inhaled or ingested.</li> <li>- Skin contact can be lethal.</li> <li>- Persistency for heavily splashed liquid agent can range from hours under average weather conditions.</li> <li>- Incapacitation may last for days or weeks; aircrews will probably be unable to fly for even longer periods.</li> </ul>	<ul style="list-style-type: none"> <li>- Symptoms may be immediate or take up to 4 hours to appear.</li> <li>- May cause stinging sensation upon contact.</li> <li>- Burns or blisters any tissue it contacts.</li> <li>- Red, watering eyes</li> <li>- Blurred vision.</li> <li>- Light sensitivity.</li> <li>- Blindness.</li> <li>- The groin and armpits, which tend to be sweaty, are more susceptible to blister agents.</li> </ul>	<ul style="list-style-type: none"> <li><input checked="" type="checkbox"/> Wear full protective ensemble as directed.</li> <li><input checked="" type="checkbox"/> Avoid contaminated surfaces.</li> <li><input checked="" type="checkbox"/> Practice contamination avoidance and expedient decontamination.</li> <li><input checked="" type="checkbox"/> Flush eyes and open wounds with water and protect from further contamination.</li> <li><input checked="" type="checkbox"/> Decontaminate skin with personal decontamination kits.</li> </ul> <p>Seek medical attention as soon as possible after any exposure or as soon as symptoms appear.</p>

<b>TABLE 5.4. BLOOD AGENT SYMPTOMS &amp; PROTECTION</b>		
<b>CHARACTERISTICS</b>	<b>SYMPTOMS</b>	<b>PROTECTION</b>
Rapid acting.	Giddiness.	<input checked="" type="checkbox"/> Wear protective mask.
Interferes with use of oxygen by body tissues.	Headache.	<input checked="" type="checkbox"/> Damages CB protective filters; change filters after agent has dissipated (as directed).
Damages blood, liver, and kidneys.	Confusion.	
Vapor or aerosol form.	Nausea.	
Persistency generally only seconds to minutes.	Rapid breathing rate or difficulty in breathing.	<input checked="" type="checkbox"/> Seek medical attention as soon as possible after any exposure or as soon as symptoms appear.
	Cramps.	
	Loss of consciousness	
	Bluing of skin.	

TABLE 5.5. CHOKING AGENT SYMPTOMS & PROTECTION		
CHARACTERISTICS	SYMPTOMS	PROTECTION
Smells like new mown hay or green corn.	Coughing.	<input checked="" type="checkbox"/> Wear your protective mask as directed.  <input checked="" type="checkbox"/> Seek medical attention as soon as possible after any exposure or as soon as symptoms appear.
The time taken to produce casualties can vary.	Choking.	
Damages respiratory tract.	Tightness of chest.	
Inhalation hazard, does not absorb through skin.	Nausea.	
Choking agents are employed only in vapor form.	Headache.	
Persistency can range from minutes to hours, depending on winds at your location.	Watering eyes.	
	Breathing discomfort.	
	Lungs fill with fluid.	
	Fatigue	

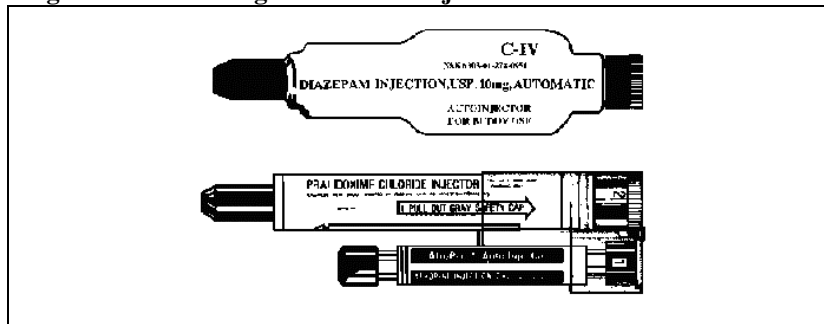
### 5.3. Chemical Warfare Agent Antidotes.

As outlined in AFJMAN 44-149, *Treatment of Chemical Agent Casualties and Conventional Military Chemical Injuries*, treatment is provided as self-aid and buddy aid. Nerve agents are the only CW agents for which we have a field antidote. The medics will provide, along with guidance, three sets of nerve agent antidote autoinjectors (one atropine injector and one 2 PAM Cl = a MARK I autoinjector kit) and a Convulsion, Antidote, Nerve Agent (Diazepam) (CANA) injector (See Figure 5.1.). At the direction of the theater surgeon, you may

also be issued a set of pyridostigmine bromide pretreatment tablets. Store the injectors in the large pocket inside your protective mask's carrier unless otherwise directed at your deployed location. Knowing where everyone's injectors are kept will enable rescuers to quickly locate and administer the antidotes. The injectors contain a needle armed with enough pressure to penetrate your protective clothing, uniform, and skin, use extreme care when handling them.

**Warning:** If pretreatment tablets are issued, **DO NOT** take them until ordered to do so.

**Figure 5.1. Nerve Agent Antidote Injectors.**



**5.3.1. Self Aid.** If you experience any nerve agent poisoning symptoms, you must **IMMEDIATELY** self-administer the autoinjector using the following directions:

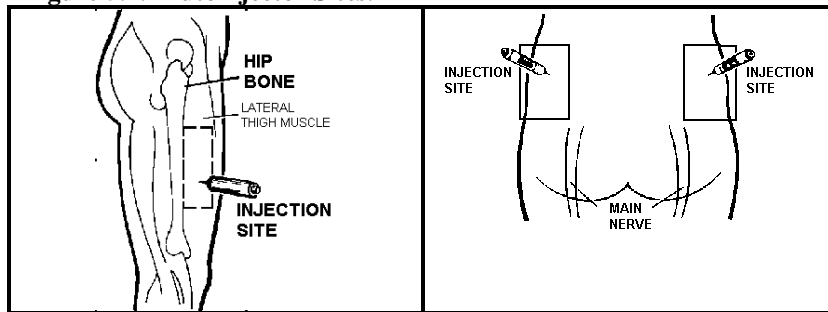
**5.3.1.1. IMMEDIATELY** put on your protective mask.

5.3.1.2. Remove one autoinjector. (In cold weather, the autoinjectors should be stored in an inside pocket of your clothing to protect the antidote from freezing.)

5.3.1.3. With your non-dominant hand, hold the autoinjectors by the plastic clip so that the larger autoinjector is on top, and both are positioned in front of you at eye level. With your dominant hand, check the injection site (thigh or buttocks) for buttons or objects in pockets which may interfere with the injections. With the same hand, grasp the atropine autoinjector (the smaller of the two) with the thumb of the first two fingers. **DO NOT** cover or hold the needle end with your hand, thumb, or fingers--you might accidentally inject yourself.

5.3.1.4. Pull the injector out of the clip with a smooth motion. The autoinjector is now armed **DO NOT** touch the needle end.

5.3.1.5. Position the green (needle) end of the injector against the injection site. Inject the needle into your thigh. If you are thinly built, inject yourself **ONLY** into the upper outer quarter of the buttock. **DO NOT** inject into areas close to the hip, knee, or thigh bone. See Figure 5.2.

**Figure 5.2. Autoinjector Sites.**

5.3.1.6. Apply firm, even pressure (not jabbing motion) to the injector until it pushes the needle into your thigh (or buttocks). Make sure you **DO NOT** hit your mask carrier, any buttons, or objects in your pocket.

5.3.1.7. Hold the injector firmly in place for at least 10 seconds. Firm pressure automatically triggers the coiled spring mechanism.

5.3.1.8. Carefully remove the autoinjector from your injection site.

5.3.1.9. Place the used atropine injector carefully between the little finger and the ring finger of the hand that is holding the remaining autoinjector and the clip. Watch out for the needle.

5.3.1.10. Pull the 2 Pam Cl injector (the larger of the two) out of the clip and inject yourself in the same manner as steps above.

5.3.1.11. Drop the clip without dropping the used injectors.

5.3.1.12. Push the needles of the used injectors (one at a time) through a pocket flap of your protective overgarment jacket and bend the needle to form a hook. It is important to keep track of all used autoinjectors so that medical personnel can determine how much antidote has already been given.

5.3.1.13. Massage the injection site if time permits.

5.3.1.14. After administering the first set of injections, **wait 5 to 10** minutes. After administering one set of injections, decontaminate your skin, if necessary, and put on any remaining protective clothing. If you continue to have symptoms of nerve agent poisoning, seek someone else (a buddy) to check your symptoms and administer the additional sets of injections if required.

*If your heart beats very rapidly and your mouth becomes very dry you have received enough antidote to overcome the dangerous effects of the nerve agent. DO NOT give yourself another set of injection. If not needed, giving yourself a second set of injections may create a nerve agent antidote overdose.*

5.3.2. **Buddy-Aid.** If an individual experiences **SEVERE** symptoms of nerve agent poisoning, immediately put on the

individual's protective equipment (mask, gloves, etc.). Then inject the individual with all three (3) sets of his/her injectors following the procedures below:

5.3.2.1. Individuals may need to seek assistance after self-aid as they may become incapacitated. A buddy must evaluate the individual to determine if additional antidotes are required to counter the effects of the nerve agent. Individuals may experience such severe symptoms that they may not be able to treat themselves. In these circumstances, other service members buddy-aid as quickly as possible. Before initial buddy aid, determine if the initial set of injectors has already been used so that no more than three sets of the antidote are administered. Administer the CANA with the third MARK I to prevent convulsions. Follow the procedures below.

5.3.2.2. **IMMEDIATELY** mask the casualty.

5.3.2.3. Position the casualty on his or her side and then position yourself near the casualty's thigh.

5.3.2.4. Remove all three autoinjector sets (or the remaining sets) and the CANA autoinjector.

***Do not use your own autoinjectors on a casualty. SAVE your own for yourself!***



5.3.2.5. With your non-dominant hand, hold the set of injectors by the plastic clip, so that the larger injector is on your top and both are positioned in front of your body at eye level.

5.3.2.6. With your dominant hand, check the injection site (thigh or buttocks) for buttons or objects in pockets which may interfere with the injections. With the same hand, grasp the atropine autoinjector (the smaller of the two) with the thumb and the first two fingers. DO NOT cover or hold the needle end with your hand or fingers - you might accidentally inject yourself.

5.3.2.7. Pull the injector out of the clip with a smooth motion. Make sure your hand DOES NOT cover the needle end. Hold the autoinjector with your thumb and two fingers (pencil writing position).

5.3.2.8. Position the green (needle) end of the injector against the casualty's injection site (thigh or buttocks as mentioned earlier).

5.3.2.9. Apply firm, even pressure (not a jabbing motion) to the injector until it pushes the needle into the casualty's thigh (or buttocks).

5.3.2.10. Hold the injector firmly in place for at least 10 seconds. Then carefully remove the atropine autoinjector from

the casualty's injection site. As before, carefully hold that while you use the next injector.

5.3.2.11. Using the 2 PAM CI injector (the larger of the two), inject the casualty in the manner described above.

5.3.2.12. Repeat the procedure immediately, using the second and third sets of autoinjectors.

5.3.2.13. Repeat the procedure using the CANA autoinjector.

5.3.2.14. Attach the CANA and all three sets of used injectors to the casualty's clothing.

5.3.2.15. Massage the injection site if time permits.

#### **5.4. Chemical Agent Detection.**

Indications of a chemical agent attack consists of the following:

5.4.1. Eyewitness reports of the attack.

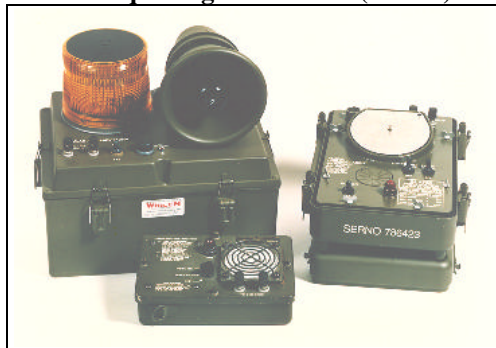
5.4.1.1. Low explosive (sounds like a dud) detonations. If you believe you may have witnessed a chemical attack, report whether it burst in the air or on the ground. While we expect air bases to be contaminated with agents in either liquid or solid form, the height of the burst provides an indication of possible coverage.

5.4.1.2. Spray attack. (If you witness a spray attack, report where the spray started and stopped.)

5.4.1.3. Environmental Indicators. Report any animals that are acting strange or have died, any noticeable changes in vegetation, and the condition of unprotected personnel. If you observe the enemy forces during ground attacks, report whether or not they were wearing chemical protective equipment.

5.4.2. Electronic detection devices detect certain chemical and biological agents. They will be placed in strategic locations throughout the base and will sound an alarm if these agents are present. Figures 5.3 and 5.4. are typical examples of electronic chemical agent detectors that you might encounter.

**Figure 5.3. Automatic Liquid Agent Monitor (ALAD).**



**Figure 5.4. M22 Alarm, Automatic Chemical Agent**



5.4.3. **M8 & M9 detection paper** (Figure 5.5.) detect certain liquid agents and must be used by every individual on their ensembles, equipment, facilities, and around work areas. See Table 5.6. for procedures on using M8 and M9 paper.

Figure 5.5. M8 and M9 Paper.



<b>TABLE 5.6. M8 AND M9 DETECTION PAPER.</b>	
M8 & M9 will detect chemical agents in liquid form and will function in snow, rain, and sleet. Always wear protective gloves when touching the detector paper. Store M8 & M9 in the zip lock bag that comes with your M9 detection paper.	
<b>Active Use</b>	
<input checked="" type="checkbox"/>	Blot or dip a piece of M8 or M9 detection paper on the suspected contaminated surface.
<input checked="" type="checkbox"/>	Do not rub or scrape detector paper across rough surfaces.
<b>Passive Use</b>	
<input checked="" type="checkbox"/>	Place detection paper on the GCE as shown in Figure 5.5.
<input checked="" type="checkbox"/>	Prior to the attack, place detection paper in the open, horizontally, where liquid contamination will be sure to come in contact with the paper during attacks.
<input checked="" type="checkbox"/>	The more detection paper placed in your work area and on equipment, the more effectively you can pinpoint contaminated areas.
<b>M8 Paper Color Changes</b>	
Gold or yellow	= (G) Nerve agents
Red-brown	= Certain (G) nerve agents
Pink or red	= (H) Blister or (L) lewisite blister agents
Dark green or blue	= (V) Nerve agents
<b>M9 Paper Color Changes</b>	
Pink, red, or any shade of red indicates the presence of liquid nerve or blister agents.	
<b>False Positive Readings</b>	
There are many things we work with every day that will cause M8 & M9 paper to give false readings. They include: temperature above 125°F (52°C), scuffs, brake fluid, aircraft surface cleaning compound, gasoline, grease, hydraulic fluid, insecticide, oils, sand colored camouflage stick, and ethylene. <b>Bottom line:</b> Report these color changes anyway.	
<b>M9 Service Life (Once removed from its shipping bag)</b>	
1 year in temperate zones (Europe, Korea, etc.)	
2 years in frigid zones (Alaska, Greenland, etc.)	
1 year (approximately) in tropic and desert regions	
<b>Inspection</b>	
<input checked="" type="checkbox"/>	Discard any M8 & M9 paper that has signs of wetting by any liquid (e.g., wrinkles, discoloration, etc.), or is dirty or damaged.
<input checked="" type="checkbox"/>	Perform a "sticky test" on M9 paper by folding a 2-inch piece adhesive side to adhesive side. Discard if paper can be pulled apart easily.

### **5.5. Chemical Contamination Control.**

By definition, contamination control (decontamination) includes procedures for reducing, removing or rendering harmless, the hazard resulting from the contamination. Although contamination avoidance before an attack is the most effective, cheapest, and easiest to perform, contamination control takes the operation to the next level. Decontamination is a manpower, time, and resource consuming process which should be limited to actions which are absolutely necessary to permit mission accomplishment.


5.5.1. When decontamination of mission essential equipment is necessary, efforts should be consistent with available resources and the contamination's effect on critical mission operations. Limit decontamination operations to those actions necessary to minimize contact hazards and to limit the spread of contamination to both personnel and equipment. There are, however, many common materials available for decontamination, to include items such as bleach, disinfectants, soap and water. See Table 5.7. for decontamination methods.

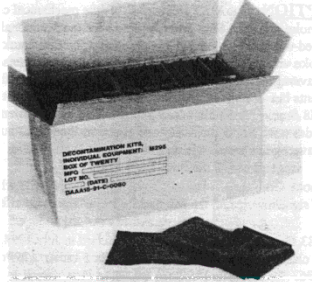
<b>TABLE 5.7. DECONTAMINATION METHODS.</b>	
<b>ITEM</b>	<b>METHOD</b>
Roads and pathways	<ul style="list-style-type: none"> <li><input checked="" type="checkbox"/> Do not use for 24-72 hours, or</li> <li><input checked="" type="checkbox"/> Cover small areas with 4 inches of earth, or</li> <li><input checked="" type="checkbox"/> Scrape top 2 inches of earth to side, or</li> <li><input checked="" type="checkbox"/> If hard surface, flush with water (runoff will be contaminated and must be addressed), or</li> <li><input checked="" type="checkbox"/> Soak with diesel fuel and burn (creates a downwind hazard).</li> </ul>
Buildings	<ul style="list-style-type: none"> <li><input checked="" type="checkbox"/> Weather (24-72 hours), or</li> <li><input checked="" type="checkbox"/> Wash down with hot, soapy water (runoff is contaminated and must be addressed).</li> </ul>
Motor Vehicles	<ul style="list-style-type: none"> <li><input checked="" type="checkbox"/> Remove bulk contamination. This may be accomplished by either scrubbing with mud, followed by rinsing, or using dry sand or earth to absorb the agent.</li> <li><input checked="" type="checkbox"/> Air-out (8-48 hours) [Driving the vehicle will increase the effectiveness of aeration].</li> <li><input checked="" type="checkbox"/> Hot water and soap are the primary method of decontamination.</li> </ul>
Aircraft	<ul style="list-style-type: none"> <li><input checked="" type="checkbox"/> Interior—IAW applicable aircraft technical orders. Open hatches to allow for aeration.</li> <li><input checked="" type="checkbox"/> Exterior--remove bulk contamination by flushing with water, if available. Concentrate on crew ingress/egress areas.</li> </ul>




TABLE 5.7. DECONTAMINATION METHODS Continued.	
ITEM	METHOD
Support Equipment	<ul style="list-style-type: none"> <li><input checked="" type="checkbox"/> Blot off surface with M295 kit (solvent soaked rags may be used).</li> <li><input checked="" type="checkbox"/> Aerate (8-48 hours) [operating equipment will increase the effectiveness of aeration].</li> <li><input checked="" type="checkbox"/> Wash with hot, soapy water, if available.</li> </ul>
Tools	<ul style="list-style-type: none"> <li><input checked="" type="checkbox"/> M295 kit or clean with organic solvent, wipe with oil, or</li> <li><input checked="" type="checkbox"/> Aerate (4 - 8 hours).</li> </ul>
Tents, Tarps, Web Gear, etc.	<ul style="list-style-type: none"> <li><input checked="" type="checkbox"/> Remove visible (bulk) contamination by any means available (water is best).</li> <li><input checked="" type="checkbox"/> Aerate (48 - 72 hours).</li> </ul>
Small Arms	<ul style="list-style-type: none"> <li><input checked="" type="checkbox"/> Immediately wipe down with M295 kit or solvent soaked rag, dry, and then oil. When time allows break down weapon, wash with hot soapy water or cleaning solvents, rinse with clean water, dry thoroughly, and oil.</li> </ul>
<p><i>Warning:</i> A vapor hazard from the chemical agent may still exist after conducting decontamination. Also, any materials used in the process will become contaminated. <i>Note:</i> Refer to T.O. 11C15-1-3 for NBC Decontamination and Decontaminating agents.</p>	

5.5.2. The **M291, M295, and M258A1** decontamination kits are available for chemical decontamination. Tables 5.8 - 5.10 provide information on each kit. Refer to T.O. 11D1-1-131, TM 3-4230-235-10, and T.O. 11D1-1-111 respectively for complete information.

<b>TABLE 5.8. M291 SKIN DECONTAMINATING KIT.</b>	
<p>The M291 kit is very effective against liquid nerve and blister agents. The kit consists of a wallet-like carrying pouch, containing six individual decon packets. Each packet contains an applicator pad filled with decontaminating powder</p>	
<b>USE</b>	
1. Don mask and hood. Do NOT tighten the hood drawstring. Do NOT fasten shoulder straps.	
2. Seek overhead cover or don poncho.	
3. Remove one packet from pouch.	
4. Tear open quickly at notch.	
5. Remove applicator pad and discard empty packet.	
6. Unfold applicator pad and slip finger(s) into handle.	
7. Thoroughly scrub exposed skin until completely covered with black powder.	
8. Switch applicator to other hand and repeat step 7.	
9. Decontaminate neck and face if exposed.	
<b>INSPECTION</b>	
<input checked="" type="checkbox"/> Inspect the kit for loose black powder. <input checked="" type="checkbox"/> If powder is detected, inspect each packet for leaks. Discard all leaking packets. <input checked="" type="checkbox"/> Reinsert good packets into pouch with tear line at bottom. <input checked="" type="checkbox"/> Immediately request an additional kit if there are less than four decon packets in your kit. Use kit until all packets are gone.	
<b>WARNING</b>	
<p>The M291 kit is for or external use only. May be slightly irritating to skin and eyes. Keep powder out of eyes, cuts, and wounds. Use water to wash toxic agents out of eyes, cuts, and wounds.            Completely decontaminate exposed skin as quickly as possible (3 min or less).</p>	

<b>TABLE 5.9. M295 SKIN DECONTAMINATING KIT</b>	
<p>The M295 kit is very effective against nerve and blister agents. Each M295 Kit consists of a carrying pouch containing four individual decon packets. Each packet contains a decon mitt filled with decon powder. Each individual mitt is comprised of absorbent resin contained within a nonwoven polyester material.</p>	
<b>USE</b>	
1. Remove decontamination packet.	
2. Tear open packet and remove decon mitt.	
3. Discard empty packet.	
4. Unfold decontamination mitt.	
5. Grasp green (non pad) side of decontamination mitt with one gloved hand, pat the other gloved hand until completely covered with powder.	
6. Insert decontaminated gloved hand into mitt, tighten wristband on glove.	
7. Decontaminate individual equipment by rubbing with mitt.	
8. Decontaminate gloved hand that was holding equipment.	
9. Discard mitt.	
10. If more contamination is present, use another mitt following procedures above.	
11. All personal equipment can be decontaminated with the mitt.	
<b>INSPECTION</b>	
<input checked="" type="checkbox"/> Inspect kit for loose black decon powder. If no powder is detected, the kit is operational.	
<input checked="" type="checkbox"/> If powder is detected, inspect each packet for leaks.	
<input checked="" type="checkbox"/> Discard all leaking packets.	
<b>WARNING</b>	
The M295 kit is for or external use only. May be slightly irritating to skin and eyes. Keep powder out of eyes, cuts, and wounds. Use water to wash toxic agents out of eyes, cuts, and wounds.	

<b>TABLE 5.10. M258A1 SKIN DECONTAMINATING KIT.</b>	
<p>The M258A1 kit is very effective against liquid nerve and blister agents. The kit consists of a plastic waterproof carrying case, containing six individual foil decon packets (3 #1s and 3 #2s).</p>	
<b>USE</b>	
1. Open lid, remove packet "1".	
2. Fold packet "1" in half at solid line, tear open at notches and remove pad.	
3. Unfold pad fully, wipe skin for 1 minute, discard pad.	
4. Remove packet "2", crush glass ampoules inside packet "2".	
5. Fold packet "2" in half, tear open at notches, remove pad letting screen fall.	
6. Unfold the pad fully, wipe skin for 2-3 minutes, discard pad.	
7. Follow these procedures if you have or suspect contamination on your <b>face</b> :	
8. Open lid, remove packet "1".	
9. Fold packet "1" in half at solid line, tear open at notches and remove pad.	
10. Unfold pad fully, wipe skin for 1 minute, discard pad.	
11. Using pad "1", wipe your hands.	
12. Take a deep breath and hold it, close your eyes, lift the mask from the chin only far enough to get your hand inside. Quickly wipe the lower part of the face and interior surfaces of the mask which contact the skin.	

<b>TABLE 5.10. M258A1 SKIN DECONTAMINATING KIT Continued.</b>
<b>INSPECTION</b>
<ul style="list-style-type: none"><li><input checked="" type="checkbox"/> Inspect for holes in packets.</li><li><input checked="" type="checkbox"/> Verify glass ampoules in packet 2 are not crushed</li><li><input checked="" type="checkbox"/> Check if the case/packets is deformed, or packets have deteriorated.</li><li><input checked="" type="checkbox"/> Minor cracks in case, rubber O-ring missing, or nylon strap missing do not constitute unserviceability.</li></ul>
<b>WARNING</b>
Some skin reaction (reddening, itching) may result from the decontamination process. The treated skin area should be washed with soap and water as soon as practical after use. Rubber gloves must be worn unless agent is on hand.

**CHAPTER 6 - INDIVIDUAL PROTECTIVE EQUIPMENT****6.1. Mask, MCU-2A/P.**

The MCU-2A/P mask with a serviceable canister filter installed protects the face, eyes, and respiratory tract from chemical and biological warfare agents and radioactive dust particles. A properly worn mask provides a gas-tight face seal which prevents unfiltered air from reaching the wearer's respiratory system.

**Figure 6.1. MCU-2A/P Mask.**



**6.1.1. Operational Limitations.** This mask is not authorized for use during industrial chemical spills. Chemicals of this nature normally require a self-contained breathing apparatus. For example, the mask would not be effective against chemicals such as ammonia, chlorine, or even carbon monoxide fumes. The

mask is not effective in confined spaces when there is insufficient oxygen to support life. The MCU-2A/P mask is simply a filter respirator; it does not supply or produce oxygen.

6.1.2. **Mask Size.** The mask comes in three sizes (short, medium, long). Correct mask size is determined by facial measurements. A spring caliper, vernier dial, and/or the M-41 Protection Assessment Test System (PATS) is required to determine proper fit. Proper mask size will be determined upon issue.

6.1.3. **Familiarization of Components.** The MCU-2/AP mask consists of the following components: (Component numbers refer to Figure 6.2.)

6.1.3.1. Facepiece: (#1) The facepiece is molded of silicone rubber which forms an effective seal on the face.

6.1.3.2. Head Harness: (#5) The head harness holds the mask to the face. It has six elastic straps, a headpad, and a quick-don pull tab.

6.1.3.3. Side Voicemitter: (#6) The side voicemitter is useful when using phones, radios, or other communications equipment.

6.1.3.4. Front Voicemitter: (#9) Located on the center of the facepiece. The voicemitters transmit the user's voice outside the mask.

6.1.3.5. Outlet Valve Cover: (#10) The outlet valve cover is a rubber cover that holds the drinking tube coupling. It fits over the end of the outlet valve body and can be easily replaced if torn, dry rotted or otherwise damaged.

6.1.3.6. Outlet Valve Assembly: (#11) The outlet valve assembly has a one-way valve at the bottom of the facepiece.

6.1.3.7. Nosecup: (#12) The nosecup is made of silicone rubber and is located inside the facepiece. The nosecup helps prevent the mask from fogging by allowing air to enter through two nosecup valves and keeping warm air off the eyelens.

6.1.3.8. Drinking Tubes: (#13) The external and internal drinking tubes are rubber tubes used with the M1 canteen cap to provide water to the wearer.

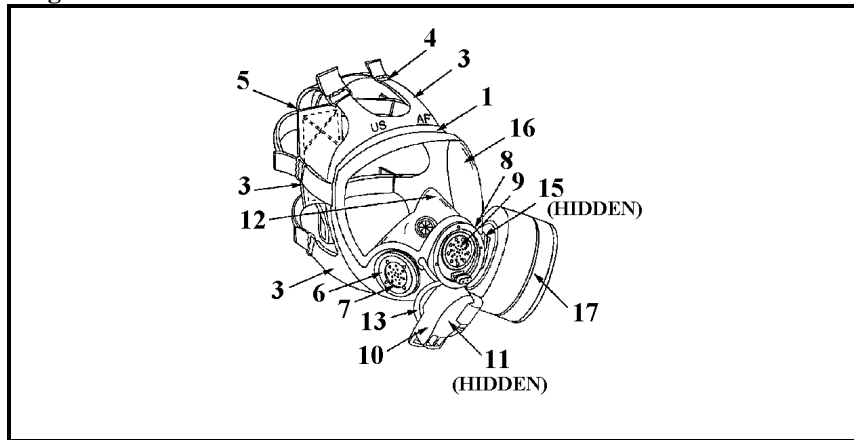
6.1.3.9. Inlet Valve Assembly: (#15) The inlet valve assembly consists of a one-way valve disc and an air deflector assembly.

6.1.3.10. Lens: (#16) The lens is made of transparent urethane and provides a wide field of vision. A transparent protective shield installed over the exterior of the lens (Outsert) protects against scratches and tears.



6.1.3.11. Canister. (#17) The C-2 canister is made with layers of impregnated charcoal which provide the filtration. The canister must be free from dirt, debris, and water.

**Figure 6.2. MCU-2A/P Protective Mask.**



6.1.4. **Inspection and Documentation.** The user must inspect the mask upon issue, every six months during peacetime, and every seven days during wartime. Document the mask's inspection on a DD Form 1574 (Serviceability Tag) or data automated product. When a serviceable C-2 canister is installed, annotate the canister lot number and the date it was installed in the remarks section of the DD Form 1574 or in an area designated on the data automated form. Use Table 6.1. for a quick reference to inspect your mask.

<b>TABLE 6.1. INSPECTING THE MCU-2/AP MASK.</b>		
<input checked="" type="checkbox"/> Inspect the mask upon issue <input checked="" type="checkbox"/> Inspect the mask every six months during peacetime and every 7 days during wartime. <input checked="" type="checkbox"/> Document inspections on the back of DD Form 1574. Numbers (#) below refer to parts of the mask labeled in Figure 6.2.		
<b>CONDEMN MASK IF:</b>		
<b>PART</b>	<b>#</b>	<b>CONDITION</b>
Interior of Mask	1 3	Cracked, torn, deteriorated, or separated between silicone, rubber, and metal parts on the face seal (1) and face piece (3).
Buckles	4	Bent, cracked, or loose where molded into the face piece tabs.
Front Voicemitter	9	Loose, punctured, dented, cracked, or four pins are not facing outwards. <b>Warning:</b> Do not attempt to loosen.
Eyelens	16	Punctured or so badly stained that normal vision is prevented or if the lens has separated from the face piece.
<b>REPLACE PART IF:</b>		
Internal Drinking Tube	*	Cracked, cut, or loose. *(not shown)
Head Harness	5	Torn, has surface dirt, mildew, fraying, or metal clips are missing on end of straps. Straps have lost their elasticity. Buckles (4) won't hold head harness straps tight.
Side Voicemitter Retaining Ring	6	Corroded. If loose, tighten using the flat portion of the "D" ring on the large strap of the carrier.

TABLE 6.1. INSPECTING THE MCU-2/AP MASK Continued.		
Side Voicemitter	7	Dented, punctured, or cracked. Remove and correctly reinstall if four pins are not facing outwards.
Outlet Valve Cover	10	Cracked, ripped, or will not firmly seat on outlet valve body. Wipe away dirt or moisture on cover with a soft, dry, clean cloth.
Outlet Valve	11	Curled, nicked, ripped, or will not seat properly. Replace if it cannot be cleaned by wiping dirt or moisture away with a soft, dry, clean cloth.
Nose Cup	12	Cracked, cut, or loose at the voicemitter. If the valve seats have pulled away from nose cup, use firm pressure and reseal valve seats in the nose cup. Replace nose cup valves if curled or torn.
External Drinking Tube	13	Cracked or cut, or if coupling is cracked, dented, or loose.
Inlet Valve Disc	15	Curled or torn.
Eyelens Outsert	16	Damage (i.e., scratches) blocks your vision.

6.1.5. **Accessories.** The mask also has the following accessories:

6.1.5.1. Mask carrier.

6.1.5.2. Protective hood.

6.1.5.3. Mask outsert. The outserts are clear or tinted polycarbonate shells. The outserts protect the lens from scratches, chemical droplets, and oil and petroleum products.

6.1.5.4. Special canteen cap. The MCU-2A/P is designed to allow the wearer to drink from a canteen while wearing the mask. The canteen must have the M1 cap installed in order to use the drinking system.

6.1.5.5. Waterproofing bag. The waterproofing bag will be used to store the mask when operating in extremely wet areas. This will protect the filter elements from getting wet.

6.1.5.6. Spectacle inserts.

6.1.6. **Care and Use.** When the MCU-2A/P series mask is issued, all maintenance is the responsibility of the user.

6.1.7. **Operational Factors.** The MCU-2A/P series mask remains serviceable as long as it meets operational inspection IAW T.O. 14P4-15-1. It must be inspected and preventive maintenance performed upon issue, prior to use, semi-annually during peacetime, and once every 7 days during wartime contingencies. A serviceable C-2 canister must be installed in the MCU-2/P Series Mask prior to use in a toxic chemical or biological environment. C2 canister(s) must be replaced after CB contamination or shelf life expiration. Table 6.2. provides more information on C2 canisters.

<b>TABLE 6.2. CANISTERS AND FILTERS.</b>	
<b>Warning:</b> Filter/canister elements will not afford protection from industrial chemicals, ammonia, or carbon monoxide, nor in areas with insufficient oxygen to support life.	
<b>CHANGE CANISTER/FILTERS WHEN:</b>	
<input checked="" type="checkbox"/>	When directed by higher authority or there is clear indication of imminent use of CB agents.
<input checked="" type="checkbox"/>	Within fifteen days after any exposure to chemical/biological agents (except blood agents).
<input checked="" type="checkbox"/>	As soon as it is safe to do so when exposed to BLOOD agents.
<input checked="" type="checkbox"/>	As soon as it is safe to do so when mechanically damaged (i.e. breaks or cuts in material or edge of seal, a bent or split connector, etc.).
<input checked="" type="checkbox"/>	If filter has been immersed in water or wetted in any way.
<input checked="" type="checkbox"/>	If you experience excessive breathing resistance. (clogged filter/canister element will increase breathing resistance but will not impair the ability of the filter to remove agents).
<b>FILTER SERVICE LIFE</b>	
<b>(Once the filter/canister is removed from the sealed package.)</b>	
<input checked="" type="checkbox"/>	2 months in tropical/desert climates (Panama, Southwest Asia, etc.)
<input checked="" type="checkbox"/>	12 months in temperate climates (Korea, Europe, etc.)
<input checked="" type="checkbox"/>	24 months in Arctic climates (Alaska, Greenland, etc.)
<b>Note:</b> Track the service life of your canister/filter by annotating the following in the remarks section of your mask's DD Form 1574: date removed from the sealed package, date it expires (according to the climate), and the lot number.	

6.1.8. **Fitting.** With the mask ready for fitting (canister installed, head harness straps loose and reversed over the front of the mask, and the outsert removed) you can fit the mask using the steps in Table 6.3.

**TABLE 6.3. MCU-2A/P FITTING PROCEDURES.**

STEP 1. Place mask on face, keeping the hair out of the way and pull the head harness over the head using the quick don tab.

STEP 2. Tighten temple straps, one at a time, using small jerking pulls until the mask feels snug.

STEP 3. Check that the headpad is centered at the high point of rear of head. Adjust if necessary.

STEP 4. Tighten the neck straps, then the forehead straps in the same manner.

STEP 5. The mask should be comfortable on the face with no straps cutting or pinching. The mask should not be so tight the nosecup presses painfully on the nose.

STEP 6. While wearing the mask, with the head harness properly adjusted, check the internal and external drinking tubes for a secure fit.

STEP 7. The last thing to check when fitting the mask is to perform a negative pressure check ("leak check") by pressing your palm over the end of the canister and inhaling. The mask will deflect and you should not feel any air entering your mask. You will have to check and adjust your mask if leaks occur.

STEP 8. You can now remove the mask. Loosen ONLY the mask neck straps. Grasp mask by outlet valve assembly and remove by pulling down, outward, and up.

**6.1.9. Donning And Doffing Mask (With Hood Attached).**

Due to the short time it takes for toxic agents to affect you, becoming an expert in donning the mask and getting an air tight seal is imperative. With suspected contamination, every step in donning the mask is important and must be done quickly and accurately. You must put the mask on before you take another breath.

**WARNING**

*Perform the steps for putting on your mask quickly. You must put the mask on before you take another breath. Toxic agents may be in the surrounding air and cause sickness or death.*

**WARNING**

*You must check the mask for leaks when it is fitted and each time you put it on. A leaky mask will not protect you from toxic agents which can cause sickness or death.*

**6.1.9.1. Donning.** Donning the mask with hood attached should take place in 15 seconds. This allows you to don the mask and get an airtight seal in nine seconds with an additional six seconds to pull the hood over the head and tighten the neck cord. Follow the steps listed in Table 6.4.

<b>TABLE 6.4. MCU-2A/P DONNING PROCEDURES.</b>	
STEP1.	STOP BREATHING!
STEP2.	Close eyes tightly.
STEP3.	Remove headgear.
STEP4.	Remove mask and hood from carrier.
STEP5.	Hold outlet valve assembly in palm of one hand. Using free hand, push forehead hair aside. Place mask on face forcing the chincup very tightly against chin. Pull head harness over head using the quick-don tab.
STEP6.	Grasp a neck strap in each hand and tighten with small jerking motions. The neck straps should be the only straps adjusted. Temple and forehead straps are adjusted when you fit the mask and then left in position.
STEP7.	Expel air held in the lungs.
STEP8.	Press palm of one hand over the canister opening. Inhale to determine whether an airtight seal of mask against face has been obtained.
STEP9.	Open eyes and RESUME NORMAL BREATHING.
STEP10.	Pull back of hood over your head so the hood covers your head. Drape cape over shoulders. Make sure the cape is under neck cord.
STEP11.	Use neck cord fastener to tighten neck cord until hood is held snugly around neck.
STEP12.	Pass straps under arms. Fasten ends to front of cape.
STEP13.	Replace headgear and close the carrier.



6.1.9.2. **Doffing.** Doffing the mask involves these five steps:

6.1.9.2.1. Unfasten underarm straps and loosen neck cord.

6.1.9.2.2. Pull back of cape forward over head and leave hood suspended from front of mask.

6.1.9.2.3. Loosen **ONLY** the mask neck straps. Grasp mask by outlet valve assembly and remove by pulling down, outward, and up.

6.1.9.2.4. Shake or wipe any moisture or frost accumulations from inside of hood and mask.

6.1.9.2.5. Properly stow mask in carrier.

6.1.10. **Hood.** You must configure the hood to the mask based on temperatures. In moderate temperature (between 30° to 90° degrees Fahrenheit), place the hood over the voicemitter/outlet valve cover. The exhausted air inflates the hood and helps prevent contaminated air from entering the hood. In extreme weather -- cold (below 30° F) or hot (above 90° F), uncover the voicemitter/outlet valve cover. In cold weather, this prevents condensed moisture from freezing inside the hood or from dripping into your clothing. In hot weather, it prevents extreme heat and humidity buildup inside the hood.

6.1.11. **Repair.** The mask has no repair parts. All repair is accomplished using replacement parts. Defective parts other than those listed in the T.O. are cause for mask replacement. If mask replacement is required keep all serviceable parts – replacement masks only include the facepiece.

6.1.12. **Operational Considerations.**

6.1.12.1. Have the proper size. Ensure you have a proper size mask by using the proper measuring caliper. A leaking mask will not protect against toxic agents.

6.1.12.2. Do not over tighten the mask. Over tightening may actually cause leaks.

6.1.12.3. Check the mask for leaks every time you put it on by performing your negative pressure or "leak" check.

6.1.12.4. Don the mask quickly. Remember it should be on and sealed before you take another breath.

6.1.12.5. Remember the limitations. The MCU-2/P Series Mask is not intended for industrial chemical use and is not effective in confined spaces where there is not enough oxygen to support life.

6.1.12.6. When wearing the mask with the hood over the outlet valve **DO NOT loosen the straps of the head harness for comfort**. If the straps are loosened, the wearer is in danger of suffocation by carbon dioxide and unprotected against toxic agents.

6.1.12.7. If you become overheated in cold weather, **DO NOT remove your mask outdoors until your head cools and sweat has dried**. Frostbite may result if the mask is removed while your face is still wet.

6.1.13. **Cleaning.** Clean the mask with mild liquid detergent and warm water. Alcohol towelettes may be used for expedient sanitation. Do not place the mask in boiling water. Do not wash the canister. Do not dry wipe the mask lens to avoid scratching.

6.1.14. **Decontamination.** The mask and hood should be decontaminated as soon as practical after CB contamination has occurred. Perform immediate decontamination using the M258A1 or M295 decontamination kits. Perform operational and thorough decontamination in accordance with the T.O.

## 6.2. Mask, M17A2.

The M17A2 mask, with serviceable M13A2 filters installed, protects the faces, eyes, and respiratory tract from chemical and biological warfare agents and radioactive dust particles. A properly worn mask provides a gas-tight face seal which prevents unfiltered air from reaching the wearer's respiratory system.

**Figure 6.3. M17A2 Mask.**



**6.2.1. Operational Limitations.** This mask is not authorized for use during industrial chemical spills. Chemicals of this nature normally require a self-contained breathing apparatus. For example, the mask would not be effective against chemicals such as ammonia, chlorine, or even carbon monoxide fumes. The mask is not effective in confined spaces when there is insufficient oxygen to support life. The M17A2 mask is simply a filter respirator; it does not supply or produce oxygen.

6.2.2. **Mask Size.** The M17A2 X-small is the only mask of this type still being fielded.

6.2.3. **Familiarization and Inspection of Components.** The M17A2 mask consists of the following components:

6.2.3.1. Faceblank: Provides the sealing surface of the mask. Pouches molded in the cheeks hold the filter elements. Deflector tubes direct filtered air across the eyelenses.

6.2.3.2. Nosecup: Prevents fogging of the eyelenses by diverting air through the outlet valves. Two nosecup valve assemblies, consisting of valve discs and seats, permit filtered air to enter nosecup, but prevent exhaled air from contacting the eyelenses.

6.2.3.3. Eyelenses and Outserts: The eyelenses are made of clear glass and are held in place by aluminum alloy eyerings. The outserts protect the glass eyelenses from damage and reduces exterior fogging.

6.2.3.4. Head Harness: Holds the faceblank to the wearer to provide an airtight seal.

6.2.3.5. Voicemitter Outlet Valve Assembly: Permits the wearer to communicate and to exhale air while preventing unfiltered air from entering. A cover surrounds the voicemitter

outlet valve assembly to protect the valve seat and disk. Exhaled air passes through four holes molded in the lower edge of the cover.

6.2.3.6. Clip And Buckle Assembly: Provides adjustable mounts for the head harness at six locations.

6.2.3.7. Flap Buttons: Fastens the filter pouch flaps so that filtered air will not escape into the main cavity of the mask except through the deflector tubes.

6.2.3.8. Inlet Valve Assemblies: The inlet cap and discs permits air to enter the filter elements and prevents air from flowing back out through the filter element. They also protect the filter elements from rain, snow, coarse particles, and physical damage. They fit over the connectors on the filter elements.

6.2.3.9. Filters: Are located in pouches inside the mask. Filters have different capabilities depending on their type. M13A1 (Black rings) are used for radiological protection and training. M13A2 (Green rings) are used for NBC protection.

6.2.3.10. Carrier - you may carry the mask in its carrier strapped to your waist or hung over your shoulder.

6.2.4. **Inspection and Documentation.** The user must inspect the mask upon issue, every six months during peacetime, and every seven days during wartime. Document the mask's

inspection on a DD Form 1574 (Serviceability Tag) or data automated product. When serviceable M13A2 filters are installed, annotate the lot number and the date it was installed in the remarks section of the DD Form 1574 or in an area designated on the data automated form. Use Table 6.5. to inspect your M17A2.

<b>TABLE 6.5. INSPECTING THE M17A2 MASK.</b>	
<input checked="" type="checkbox"/> Inspect the mask upon issue <input checked="" type="checkbox"/> Inspect the mask every six months during peacetime and every 7 days during wartime. <input checked="" type="checkbox"/> Document inspections on the back of DD Form 1574.	
<b>CONDEMN MASK IF:</b>	
<b>PART</b>	<b>CONDITION</b>
Faceblank	Damaged, dry rotted, cracked, torn, deteriorated, ripped button holes, or unserviceable lot numbers
Clip & Buckles	Bent, cracked, or loose where molded into the faceblank tabs.
Voicemitter	Damaged
Eyelens	Punctured or so badly scratched that normal vision is prevented or if the lens has separated from the faceblank.
<b>REPLACE PART IF:</b>	
Drinking Assembly	Nonfunctional, cracked, cut, or loose tubes,
Head Harness	Torn, mildew, fraying, or metal clips missing on end of straps. Straps have lost their elasticity. Buckles won't hold head harness straps tight.
Inlet Valve & Caps	Disfigured, cracked, ripped, or will not firmly seat on cap, Cap damaged or outer fabric worn off.
Outlet Valve & Cover	Disfigured, cracked, ripped, or will not firmly seat on outlet valve body.
Flap Buttons	Damaged or missing
Nose Cup	Damage, distortion, improper attachment, and positioning.
External Drinking Tube	Cracked or cut, or if coupling is cracked, dented, or loose.
Temple pins	broken, worn, or missing
Carrier	Damage, wear, and missing components
Eyelens Outserts	Damage (i.e., scratches) blocks your vision.

6.2.5. **Accessories.** The M17A2 has the same basic accessories as the MCU-2/AP mask (special canteen cap, waterproofing bag, and spectacle inserts designed for this mask). One unique



accessory is the winterization kit which is installed when field operations in subzero temperatures are anticipated.

6.2.6. **Care and Use.** When the M17A2 mask is issued, all maintenance is the responsibility of the user.

6.2.7. **Operational Factors.** The M17A2 series mask remains serviceable as long as it meets operational inspection IAW T.O. 14P4-9-31. M13A2 filters are the serviceable filters for the M17A2 mask. GREEN colored connector ring can visually identify the M13A2s. Other colors may be used for training, but are not considered serviceable. M13A2 filters must be replaced after CB contamination or shelf life expiration. Table 6.2. provides more information on M13A2 filters.

6.2.8. **Fitting.** The mask will be fitted using the procedures in Table 6.6.

**TABLE 6.6. M17A2 FITTING PROCEDURES.**

STEP 1. Loosen the head harness straps and don the mask.  
STEP 2. Hold the mask firmly against the chin and center the head harness pad in the middle of the back of the head.  
STEP 3. Hold it there with one hand.  
STEP 4. Remove the hand from the chin position and tighten each of the forehead straps with a rapid pull or jerk (just enough to remove any slack).  
STEP 5. Tighten bottom straps with a rapid pull or jerk, followed by the middle straps with steady, simultaneous pull toward the back of head.  
STEP 6. Examine eye positions to see that the eyes are centered in the eyelenses.  
STEP 7. Check to see that the nose cup does not press painfully on the edge of nose or that the mask does not cut into the wearer's throat.  
STEP 8. Check to be sure that the edge of the mask does not touch the ears.  
STEP 9. Test for a proper seal of the mask by pressing the palms of the hands firmly over the inlet valve cover openings. Do not press too hard as to distort the mask. Block the inlets, inhaling normally and holding your breath for 10 seconds. If the facepiece collapses and remains collapsed during this test period, you should have an effective airtight seal. Locate the leak and eliminate the cause if the mask does not properly seal.  
Proper fit is attained when the mask comes well up on the forehead and the edge of the facepiece is close to the ears.

6.2.9. **Donning And Doffing.** Your mask should already be fitted to your face; therefore, it's just a matter of quickly donning your mask to ensure survivability. Due to the short time from agent detection to mask donning, the wearer must become an expert in donning the mask and getting an airtight seal in only nine seconds with an additional six seconds to adjust the hood when attached. Donning procedures are shown in Table 6.7.

**WARNING**

*Perform the steps for putting on your mask quickly. You must put the mask on before you take another breath. Toxic agents may be in the surrounding air and cause sickness or death.*

**WARNING**

*You must check the mask for leaks when it is fitted and each time you put it on. A leaky mask will not protect you from toxic agents which can cause sickness or death.*

**TABLE 6.7. M17A2 DONNING PROCEDURES.**

<b>Note: The mask should already have been fitted.</b>	
STEP1.	STOP BREATHING!
STEP2.	Close eyes tightly.
STEP3.	Remove headgear.
STEP4.	Remove mask and hood from carrier.
STEP5.	Don Mask. Grasp the lower head harness straps near the buckles. With the hands on the head harness straps, pull the mask up onto the face. Settle the chin snugly in the chin pocket of the facepiece and place the head pad in the middle of the back of the head. Make sure that the straps of the head harness lie flat against the head.
STEP6.	Clear Mask. Place the palm of one hand firmly over the openings in the bottom of the voicemitter-outlet valve assembly cover. Clear the mask by forcing exhaled air to escape around the facepiece and clearing the mask of contaminated air.
STEP7.	Seal Mask. Press the palms of the hands over the inlet valve assemblies and inhale to ensure an airtight seal.
STEP8.	Open eyes and RESUME NORMAL BREATHING.
STEP9.	Pull back of hood over your head so the hood covers your head. Drape cape over shoulders. Make sure the cape is under neck cord.
STEP10.	Use neck cord fastener to tighten neck cord until hood is held snugly around neck.
STEP11.	Pass straps under arms. Fasten ends to front of cape.
STEP12.	Replace headgear and close the carrier.

6.2.9.1. Donning. Once the mask is on, pull the back of the hood over the head so that the hood covers the head. Drape the cape over the shoulders and make sure the cape is under the neck cord. Fasten the neck cord and underarm straps. Don your headgear and close the carrier.

6.2.9.2. Doffing. To doff the mask:

6.2.9.2.1. Unfasten the underarm straps, loosen the neck cord, pull the hood over in front of the mask, and remove the mask.

6.2.9.2.2. Shake or wipe the moisture or frost accumulation from the inside of the hood and mask.

6.2.9.2.3. Gather the cape of the hood to one side of the facepiece and replace the mask and hood in the carrier.

6.2.10. **Hood.** To increase operational efficiency, you must make sure certain adjustments to the hood based on temperatures. In moderate temperature (between 30° to 90° degrees Fahrenheit), place the hood over the voicemitter/outlet valve cover. The exhausted air inflates the hood and helps prevent contaminated air from entering the hood. In extreme weather -- cold (below 30° F) or hot (above 90° F), uncover the voicemitter/outlet valve cover. In cold weather, this prevents condensed moisture from freezing inside the hood or from

dripping into your clothing. In hot weather, it prevents extreme heat and humidity buildup inside the hood.

6.2.11. **Repair.** The mask has no repair parts. All repair is accomplished using replacement parts. Defective parts other than those listed in the T.O. are cause for mask replacement.

6.2.12. **Operational Safety Tips.** Safety is paramount when using any protective equipment.

6.2.12.1. Ensure you have a proper fit on your mask. A leaking mask will not protect against toxic agents. Do not over tighten the mask. Over tightening may actually cause leaks.

6.2.12.2. Check the mask for leaks every time you put your mask on.

6.2.12.3. Don the mask quickly. Remember it should be on and sealed before you take another breath. It should only take you nine seconds to don, clear, and seal the mask.

6.2.12.4. The M17A2 is not intended for industrial chemical use and is not effective in confined spaces where there is not enough oxygen to support life.

6.2.12.5. When wearing the mask with the hood over the outlet valve, do not loosen the straps of the head harness for comfort.

If the straps are loosened, the wearer is in danger of suffocation by carbon dioxide and unprotected against toxic agents.

6.2.12.6. If you become overheated in cold weather, do not remove your mask outdoors until your head cools and sweat has dried. Frostbite may result if the mask is removed while your face is still wet.

6.2.12.7. Serviceable M13A2 filters must be installed in the M17A2 prior to use in a toxic chemical or biological environment.

6.2.13. **Cleaning.** Clean the mask with mild liquid detergent and warm water. Alcohol towelettes may be used for expedient sanitation. Do not place the mask in boiling water. Do not wash the filters. To clean the mask, prepare a solution of warm soapy water (ideally 110° to 125° degrees Fahrenheit.).

6.2.13.1. Remove the hood and eyelens outserts.

6.2.13.2. Remove the filter elements.

6.2.13.3. Remove the headharness.

6.2.13.4. Remove the voicemitter cover.

6.2.13.5. Wash the mask thoroughly inside and out with the warm soapy water using a sponge or soft cloth.

- 6.2.13.6. Rinse thoroughly with clear water.
- 6.2.13.7. Allow the mask to dry ensuring all water is gone (Especially inside the filter pouches.).
- 6.2.13.8. Replace everything you took off the mask.
- 6.2.13.9. You can use warm soapy water as well to clean the hood.
- 6.2.13.10. Soiled carriers should be cleaned by dry brushing or by brushing with a wet brush dipped in water.
- 6.2.14. **Decontamination.** The mask and hood should be decontaminated as soon as practical after CB contamination has occurred. Perform immediate decontamination using the M258A1 or M295 decontamination kits. Perform operational and thorough decontamination in accordance with the T.O.

### **6.3. Ground Crew Ensemble.**

Ground crew ensembles (GCE), whether they be the Battle Dress Overgarment (BDO) (Table 6.8.) or the Joint Service Lightweight Integrated Suit Technology (JSLIST) Overgarment (Table 6.10) provides the user with whole body protection from both liquid and vapor wartime chemical agents if worn properly.



6.3.1. A complete GCE includes a protective mask, hood, overgarment, protective gloves and glove inserts, and footwear covers.

6.3.1.1. **Sizes.** JSLIST OG - 7 sizes available (coat and trousers packaged separately), woodland or desert pattern. BDO - 8 sizes available (coat and trousers packaged as a single item), woodland or desert pattern.

6.3.1.2. **Protective gloves:** butyl rubber, gauntlet style. Two types: 7 mil and 14 mil thickness. 7 mil provides more dexterity. 14 mil are standard issue. There are four sizes available (small, medium, large, extra large)

6.3.1.3. **Glove inserts:** cotton, gauntlet style, three sizes available (small, medium and large)

6.3.1.4. **Footwear covers:** come in three types: four eyelet, five eyelet, and green or black vinyl overshoes (GVOs/BVOs): Four eyelet type, two sizes: small and large. Five eyelet type, two sizes: small and large. GVO/BVO, available in 12 full sizes (3-14) -- no half sizes available.

6.3.1.5. **Multipurpose Overboot (MULO):** A one-piece overboot worn over combat or field boots utilizing an integrated strap/clip closure system. This is a future fielding item that will replace current overboots.


6.3.2. Limitations caused by wearing a GCE include a decrease in vision, communications, movement, dexterity, and sense of touch. Heat burden is also a problem.

6.3.3. **GCE Inspection.** The individual user is responsible for inspection of the GCE. Inspections must be done prior to use and every 12 months. **Do Not** remove any item from its factory bag for the sole purpose of inspection or sizing. As a minimum ensure:


6.3.3.1. Absence of wetting, holes, tears. Check for cleanliness.

6.3.3.2. All fasteners operate properly.

6.3.3.3. Absence of dry rot, brittleness, holes, or tears in the gloves and boots.

<b>TABLE 6.8. BATTLE DRESS OVERGARMENT.</b>	
<p><b>Technical Reference:</b> 14P3-1-141</p> <p><b>Identification:</b> Write your abbreviated rank and full last name on strips of tape (or olive drab cloth tape when camouflage is required):</p> <ul style="list-style-type: none"> <li><input checked="" type="checkbox"/> Helmet: front and rear.</li> <li><input checked="" type="checkbox"/> Protective Hood: above the mask and in the middle of the back of the head.</li> </ul> <p>Suit: right breast jacket pocket flap.</p>	
<b>WEAR TIMES</b>	
<p><b>Battle Dress Overgarment (BDO):</b></p> <ul style="list-style-type: none"> <li>◆ Once the factory bag is opened, the BDO may be worn up to 22 days.</li> <li>◆ Wear time may be extended to 30 days, with slight increase in risk, at the discretion of the commander. Extensions beyond 22 days depend on the physical condition of the BDO. If heavily worn or soiled, the wear time should not be extended.</li> <li>◆ The BDO should be changed within 24 hours after contact with liquid contamination.</li> <li>◆ A wet BDO will afford some protection; however, its protective capabilities are reduced. Wear wet weather gear over the overgarment to protect it from getting wet.</li> </ul>	
<p><b>Green Vinyl Overshoes (GVO):</b></p> <ul style="list-style-type: none"> <li>◆ Provide up to 14 days of protective wear (total) as long as they are free from cracks, tears, and punctures. Inspect the GVOs regularly to ensure integrity.</li> <li>◆ After contact with chemical agents they should be changed within 12 hours, extendable to 24 hours with some increase in risk.</li> </ul>	
<p><b>Decontamination.</b> BDO can be decontaminated by aeration and/or using the M295 decon kit. Do not exceed the contaminated wear time.</p>	

<b>TABLE 6.9. DONNING AND DOFFING THE BDO OVERGARMENT.</b>	
The Battle Dress Overgarment (BDO) is normally worn over the duty uniform. Heavy winter jackets, parkas, body armor, and wet weather gear should be worn "over" the BDO.	
<b>DONNING</b>	
<b>Mask with Hood</b>	<input checked="" type="checkbox"/> Follow mask donning procedures in Table 6.4. (MCU-2/AP) and 6.7. (M17A2).
<b>Pants</b>	<input checked="" type="checkbox"/> Open leg openings and fly and loosen side pull straps. <input checked="" type="checkbox"/> Don the pants. Fasten both fly snaps and zipper. <input checked="" type="checkbox"/> Adjust side pull snaps to provide a snug fit around waist (Ensure BDU blouse is inside GCE pants).
<b>Footwear Covers</b>	<input checked="" type="checkbox"/> Don footwear covers or GVOs <input checked="" type="checkbox"/> Close pants leg opening over footwear cover. <input checked="" type="checkbox"/> Draw ankle cords up tight and tie in a bow knot.
<b>Protective Gloves</b>	<input checked="" type="checkbox"/> Don glove inserts (gauntlet under BDU sleeves). <input checked="" type="checkbox"/> Don protective rubber gloves (gauntlet over BDU sleeves).
<b>Jacket</b>	<input checked="" type="checkbox"/> Don jacket, close zipper, and fasten front snaps. <input checked="" type="checkbox"/> Secure rear jacket snaps to snaps on pants. <input checked="" type="checkbox"/> Draw waist cord up tight and tie in a bow knot.
<b>DOFFING</b>	
The order for doffing an uncontaminated GCE in an uncontaminated environment does not matter. One method is to doff components in the opposite order they were donned. The order for doffing a contaminated GCE is critical. You must follow the procedures listed at the contamination control area (CCA). <b>REMEMBER: Follow the doffing procedures for your type of mask..</b>	

<b>TABLE 6.10. JOINT SERVICE LIGHTWEIGHT INTEGRATED SUIT TECHNOLOGY.</b>		
<p><b>Technical Reference:</b> 14P3-1-171</p> <p><b>Identification:</b> Write your abbreviated rank and full last name on strips of tape (or olive drab cloth tape when camouflage is required):</p> <ul style="list-style-type: none"> <li><input checked="" type="checkbox"/> Helmet: front and rear.</li> <li><input checked="" type="checkbox"/> Protective Hood: above the mask and in the middle of the back of the head.</li> <li><input checked="" type="checkbox"/> Suit: right breast jacket pocket flap.</li> </ul>		
<b>WEAR TIMES</b>		
<b>Uncontaminated wear time (Whichever comes first)</b>		
6 laundryings	45 day wear	10 year shelf life
<b>Contaminated wear time:</b>		
◆ 24hrs (regardless of type of contamination).		
◆ A wet BDO will afford some protection; however, it's protective capabilities are reduced. Wear wet weather gear over the overgarment to protect it from getting wet.		
<b>Green Vinyl Overshoes (GVO):</b>		
◆ Provide up to 14 days of protective wear (total) as long as they are free from cracks, tears, and punctures. Inspect the GVOs regularly to ensure integrity.		
◆ After contact with chemical agents they should be changed within 12 hours, extendable to 24 hours with some increase in risk.		
<b>Decontamination.</b> JSLIST can be decontaminated by aeration and/or using the M295 decon kit. Do not exceed the contaminated wear time.		
<b>Laundering.</b> The JSLIST can be laundered up to six times for hygiene purposes. Only standard laundering detergent and water should be used.		

<b>TABLE 6.11. DONNING AND DOFFING THE JSLIST OVERGARMENT.</b>	
The JSLIST Overgarment (OG) is worn over the duty uniform. Heavy winter jackets, parkas, body armor, and wet weather gear should be worn "over" the OG	
<b>DONNING</b>	
<b>Mask with Hood</b>	<ul style="list-style-type: none"> <li><input checked="" type="checkbox"/> Follow mask donning procedures in Table 6.4. (MCU-2/AP) and 6.7. (M17A2).</li> </ul>
<b>Pants</b>	<ul style="list-style-type: none"> <li><input checked="" type="checkbox"/> Close the slide fastener and fasten the two fly opening snaps.</li> <li><input checked="" type="checkbox"/> Adjust the waistbands on either side of the waist with the hook and pile fastener tapes for a snug fit.</li> <li><input checked="" type="checkbox"/> Pull the suspenders over each shoulder; connect the plastic clip to the end at the top of the waist.</li> </ul>
<b>Footwear Covers</b>	<ul style="list-style-type: none"> <li><input checked="" type="checkbox"/> Wear them over your standard footwear, fully fastened, with the upper portion worn underneath the overgarment pant leg.</li> <li><input checked="" type="checkbox"/> Secure the leg openings and secure the hook and pile fasteners over the footwear covers.</li> </ul>
<b>Gloves</b>	<ul style="list-style-type: none"> <li><input checked="" type="checkbox"/> Don cotton inserts and then protective gloves</li> </ul>
<b>Jacket</b>	<ul style="list-style-type: none"> <li><input checked="" type="checkbox"/> Don the coat; fasten and close the slide fastener up as far as mid-chest.</li> <li><input checked="" type="checkbox"/> Pull the bottom of the coat down over the trousers</li> <li><input checked="" type="checkbox"/> Secure the hook and pile fasteners on each sleeve securely over the gloves</li> <li><input checked="" type="checkbox"/> Connect crotch strap to front of coat</li> </ul>

<b>TABLE 6.11. DONNING AND DOFFING THE JSLIST OVERGARMENT Continued.</b>	
<b>Coat</b>	<ul style="list-style-type: none"> <li><input checked="" type="checkbox"/> Pull the OG hood over the chemical protective mask. Close the slide fastener on the coat completely and secure the hook and pile fastener tape up as far as the top of the slide fastener</li> <li><input checked="" type="checkbox"/> Place the edge of the hood around the edge of the mask; snap the barrel locks together, pull on the drawcord to maintain a good seal around the mask. Using the buddy system, check the seal around the hood and mask to ensure the hood is positioned properly and skin is not exposed</li> <li><input checked="" type="checkbox"/> Bend over and reach between the legs and grasp the waist elastic coat retention cord; pull down firmly on the coat retention cord to ensure it tightens around the waist. Bring the coat retention cord loop forward through the legs</li> <li><input checked="" type="checkbox"/> Place the coat retention cord loop over the webbing strip at the bottom of the coat; fasten the webbing strip snap to keep the coat retention cord loop in place. Pull on the drawcord ends at the bottom front of the coat to tighten the drawcord around the waist and tie to secure</li> </ul>
<b>DOFFING</b>	
<p>The order for doffing an uncontaminated GCE in an uncontaminated environment does not matter. One method is to doff components in the opposite order they were donned. The order for doffing a contaminated GCE is critical. You must follow the procedures listed at the contamination control area (CCA).</p> <p><b>REMEMBER: Follow the doffing procedures for your type of mask.</b></p>	

#### **6.4. Heat Stress.**

The harder people work, the faster they tire and accumulate body heat. Supervisors must set work rates (work/rest cycles) for their people or they may become casualties from heat stress. Guidance for work/rest cycles can be found in AFMAN 32-4005, *Personal Protection and Attack Actions*, Attachment 13. Heat stressed individuals cannot adequately assess their own condition. Rest periods must include sufficient time in an area that promotes cooling (shade, air conditioned area, etc.). Water consumption is critical to avoid dehydration. Drink as much water as possible, even if you are not thirsty, because thirst alone will not ensure adequate water intake. Before beginning work in MOPP gear, drink one-half to one quart of water and then continue drinking throughout the work cycle.



**CHAPTER 7 - BIOLOGICAL WARFARE DEFENSE****7.1. Classification of Biological Agents.**

Biological agents can be classified according to their biological type, uses, operational effects, and physiological action. Operationally, biological agents are best thought of as either pathogens or toxins. Pathogens “bugs” are living organisms. As such they require certain conditions of temperature, humidity, protection from sunlight, and a susceptible host population in order to wreck havoc. They must overcome host natural defenses and essentially “set up housekeeping” before illness occurs. This takes time. Therefore, the most likely use of these pathogens will be in special operations forces (SOF), covert, terrorist or other “non-conventional” attack. That way, the target population isn’t alerted to the release immediately, the bug has time to spread through a larger population, and identification of the pathogen becomes much more difficult. Toxins are really no different than some chemical agents. They are chemical compounds produced by some living organism.

7.1.1. **Pathogens** are disease-producing microorganisms that are either naturally occurring or altered by random mutation or recombinant deoxyribonucleic acid (DNA) techniques.

7.1.2. **Toxins** are poisons naturally produced through the activities of living organisms.

## **7.2. Biological Agent Effectiveness.**

The duration of effectiveness of a biological agent depends on the characteristics of the agent, environmental factors, and any residual hazards. Solar (UV) radiation, relative humidity, wind speed and temperature gradient are the most important weather factors in determining duration of effectiveness.

7.2.1. Biological agents may be disseminated as aerosols, liquid droplets (toxins only), or dry powders. To a certain extent the state in which an agent normally exists determines its delivery state, use, duration of effectiveness, and physiological action.

## **7.3. Characteristics of Biological Agents.**

Certain characteristics of biological agents make them viable weapons. The first step in preparing a defense is to understand the nature of the threat. The following is a list of general characteristics of biological weapons which make them viable weapons:

7.3.1. Pathogens are living agents. Under favorable conditions, pathogenic microorganisms can reproduce and multiply in the host. Therefore, a small number of pathogens may constitute a grave risk to the health of a person. Some contagious pathogens spread from individual to individual; therefore, personnel not in the initial area of attack could become casualties. Following large-scale dissemination of a biological agent, an initial outbreak of disease of epidemic proportion might occur. Pathogens often have a delayed action effect. A lag time or

incubation period, often several days long, must elapse between the time the target is exposed to an agent and the time the first disease symptoms appear. Effects might be either lethal or incapacitating.

7.3.2. The identification of microorganisms is difficult and slow because their presence cannot be detected by the unaided senses.

7.3.3. Biological warfare (BW) agents lend themselves well to covert use because the small amounts of material needed are easily concealed, transported, and used in sabotage operations. BW agents are also the least expensive of the weapons of mass destruction (WMD). An enemy with a modest biological research or production base; such as in the pharmaceutical or brewing industry, can produce biological agents.

7.3.4. A vector is a carrier of the biological agent used to transmit disease. Examples of vectors include:

7.3.4.1. Mosquitoes - the virus of yellow fever is transmitted by the bite of a mosquito.

7.3.4.2. Flies - typhoid fever, bacillary, and Asiatic cholera are examples of diseases which may be caused by flies.

7.3.4.3. Fleas - the common rat flea is the chief vector of bubonic plague.

7.3.4.4. Lice - the human body louse is the vector for the rickettsiae which cause epidemic typhus and trench fever.

**7.4. Protective measures.**

Protective measures increase your chances of survival. Some basic protective measures include: good health, good hygiene, proper sanitation, your individual protective equipment (i.e. protective mask and suit), and keeping your immunizations current.

7.4.1. Poor physical health reduces your body's ability to resist and fight infections. Regular exercise and balanced meals build and maintain your body's natural resistance to diseases.

7.4.2. Thoroughly wash all fruits and vegetables before eating. Ensure that all foods, especially meats, are thoroughly cooked. Drink only from approved water sources because untreated water may contain disease-causing bacteria.

7.4.3. Poor personal hygiene increases your chance of infection. An unclean body provides an ideal breeding ground for disease causing bacteria, germs, and parasites such as fleas and ticks. Washing with soap and water is an effective means of preventing or destroying areas in which these agents breed.

7.4.4. Unsanitary living conditions also serve as an ideal breeding ground for disease, especially with the use of vectors. Animals and insects thrive in unsanitary conditions, and if left uncontrolled, the spread of disease increases rapidly.

7.4.5. Your individual protective equipment such as your mask and overgarment provide protection against all biological warfare agents.

7.4.6. It's important to keep your immunizations up-to-date at all times. This greatly reduces your chances of disease caused by BW agents.

7.4.7. You probably will not know immediately when you have become contaminated. However, if you know or suspect toxins or other biological agents are present, remove the contamination with soap and water. If water is not available, use your decon kit in the same manner as described for chemical agent decontamination.

### **7.5. Biological Decontamination.**

From a practical standpoint, BW contamination control is a combination of standard disease prevention measures and traditional CW contamination avoidance and decontamination measures.



## **CHAPTER 8 - NUCLEAR WARFARE DEFENSE ACTIONS & DEPLETED URANIUM SAFETY**

### **8.1. Introduction.**

Nuclear weapons are the most destructive man-made force on the face of the earth. Following a nuclear attack, fallout that contains lethal amounts of radioactive debris may be all around us. Most people believe there is no hope of survival in nuclear warfare. Naturally, the chances of survival assume that one is away from ground zero and can find adequate blast and thermal protection.

### **8.2. Nuclear detonations.**

All nuclear detonations create blast, heat, and nuclear radiation. Their relative effects are largely determined by the yield (strength) of the weapon and the altitude at which the weapon detonates. Therefore, nuclear bursts are divided into four categories: high altitude, air, surface, and subsurface.

8.2.1. A high altitude burst occurs at an altitude greater than 30,000 meters or about 100,000 feet above sea level.

8.2.1.1. A high energy electromagnetic pulse (EMP) can damage electrical, solid state, and unprotected electronic components. Wide range communications interruptions result and may last for many hours due to the EMP generated during the burst.

8.2.1.2. The light or "flash" from the weapon's fireball may produce eye injuries to personnel witnessing the burst even though they are many miles away.

8.2.2. An air burst occurs at an altitude below 30,000 meters, but its fireball does not contact the earth's surface.

8.2.2.1. The fireball and blast will destroy nearly everything at ground zero. Further out, some of the greatest damage will be from secondary fires.

8.2.2.2. Initial radiation from any type of burst is emitted for about the first minute following detonation. However, there is essentially no fallout generated from an air burst. While the fireball is still glowing, a tremendous amount of radioactive energy is released.

8.2.2.3. The blast destroys buildings, overturns vehicles, shatters glass, and can splinter wood creating a lethal shower of debris for anyone caught in its path.

8.2.2.4. The blast wave can cause broken bones, head trauma, or internal injuries with a high potential for sudden death.

8.2.3. A surface burst detonates on or slightly above the surface of the earth. The fireball will actually touch the land or water. A large crater is formed on land.

8.2.3.1. The fireball carries tons of earth from the crater into the air forming a "mushroom" shaped radioactive cloud. This mushroom cloud will be black or very dark from the debris. This distinction can easily separate a surface from an airburst because the cloud from an airburst would be almost white.

8.2.3.2. The heaviest amount of fallout occurs in the immediate area of ground zero and returns to earth within 24 hours.

8.2.3.3. The radioactive cloud creates a residual radiation hazard that can extend hundreds of kilometers downwind. This type of burst causes the most severe post-attack problems for us.

8.2.4. A subsurface burst occurs beneath the surface of land or water. Cratering will generally result.

8.2.4.1. If the fireball does not penetrate above the surface, the prime hazard is heavy ground or water shock. If the burst is shallow enough to vent to the surface then blast heat, ground shock, and very heavy local radioactive fallout will be present.

### **8.3. Nuclear Yield.**

The "yield" of a nuclear weapon is a measure of the amount of explosive energy it can produce. It is the usual practice to state the yield in terms of the quantity of TNT that would generate the same amount of energy when it explodes. For example, a 1-kiloton nuclear weapon is one which produces the same amount



of energy as does 1 kiloton of TNT. One kiloton equals 1,000 tons.

#### **8.4. Nuclear Detonation Effects.**

Regardless of yield, a nuclear detonation produces blast, heat, and radiation.

8.4.1. The blast effect occurs very quickly and can cause significant amounts of damage and personal injury. The force of the blast can be much greater than any force experienced in the strongest hurricane. You could be seriously injured by flying debris or by being blown into other objects. Lung damage and eardrum ruptures will be common.

8.4.2. Thermal or heat injuries occur from direct thermal absorption and from indirect causes such as flash fires or flame. Unless it is scattered, thermal radiation from a nuclear explosion, like ordinary light travels in straight lines from the fireball. Any solid, opaque material. For example, a wall, a hill, or a tree between the object and the fireball will act as a shield and provide protection from thermal radiation.

8.4.3. Regardless of the height of burst, approximately 85% of the explosive energy from a nuclear burst produces air blast and thermal radiation. That breaks down to 50% blast and 35% thermal energy. The remaining 15% of the energy is released as nuclear radiation. The nuclear radiation is categorized as either initial or residual. Initial radiation of 5% is the total fission

energy, produced within a minute or so of the explosion. The final 10% represents residual radiation also referred to as delayed fallout that occurs over a period of time.

8.4.4. Fallout is composed of radioactive particles from the bomb and material from the surface of the earth carried into the air by the explosion. The larger particles return to earth within 24 hours, but the smaller dust particles take up to several months to fall.

## **8.5. Types of Radiation.**

8.5.1. Beta and gamma radiation are the primary nuclear hazards from a detonation. Alpha radiation is present mostly with a nuclear weapons accident where parts of a weapons system are broken apart.

8.5.2. Beta radiation is also found in radioactive fallout. Beta particles which remain on our skin can cause beta burns similar to severe sunburn, but do not penetrate to internal organs as gamma rays can.

8.5.3. Gamma radiation penetrates everything to some extent. It is present during the nuclear burst and also in the radioactive fallout. Gamma radiation affects your whole body and may cause radiation sickness and death when enough energy is absorbed.

8.5.4. Alpha radiation is emitted from the actual radioactive material that escaped during the fission process. Because of their greater mass and charge, alpha particles are much less penetrating than beta particles or gamma rays. Alpha radiation is primarily an internal hazard mostly associated with nuclear weapons accidents.

## **8.6. Protective Measures.**

8.6.1. Shelters provide protection from blast and heat. Your most important initial action is seeking protection from the blast wave, heat, and flying debris. Seek shelter to provide the greatest amount of safety against these effects.

8.6.2. Take cover immediately: If you are outside a shelter during a nuclear burst, take cover in a ditch, revetted area, culvert, or a road drainage tunnel. Expedient shelters can be constructed with accessible materials in a relatively short time. If all else fails, immediately take a prone position. Tightly cover your face with both hands. Do not move until the blast wave has passed completely. Completely means that the incident wave and any reflected blast waves must pass. Preplanning should include protective measures against thermal effects. Anything in direct line of sight to a burst may burn.

8.6.3. Time, distance, and shielding are your best overall protection against residual or delayed radiation hazards. Minimize your time outside of shelter. Remain inside your

protective shelter unless the mission dictates otherwise. If you must work outside, do so as quickly as possible and get back inside without delay.

8.6.4. Protection factor shelters, such as massive concrete structures with few or no windows, allow much less radiation to penetrate them reducing exposure to the people inside. This is an important factor in the exposure control program. For example, even a simple shelter such as a wood frame structure can reduce your exposure by a factor of 10 or more. Protect your bare skin from fallout. Radioactive fallout exposure will be minimized by wearing gloves, field jacket and hood, blousing your pants, and taping openings in your uniform. Cover open cuts or wounds and avoid breathing fallout. Wear a handkerchief tied over your mouth or use your protective mask.

### **8.7. Radiation Sickness.**

When fallout occurs, radioactive material may enter the body through inhalation, ingestion, or absorption. Radiation sickness can result from a single exposure to high energy radiation, exposure to high-levels of fallout, or from repeated exposures to both. Radiation sickness is not contagious. It's caused by radiation destroying cells within our bodies at a rate the body cannot overcome.

8.7.1. Early symptoms of radiation sickness are nausea, vomiting, loss of appetite and illness. Subsequent symptoms

producing severe body fluid loss, internal hemorrhaging and diarrhea indicate high levels of radiation poisoning.

8.7.2. In most cases, affected people will require medical treatment such as whole blood transfusions and antibiotics to control infections. Increased fluid intake may also be necessary. Medical treatment in your shelter may be extremely limited. Rest and relaxation may be your only treatment until medical assistance becomes available.

### **8.8. Nuclear Contamination Avoidance.**

The following rules will help you avoid contact with radioactive fallout:

8.8.1. Always try to avoid unnecessary exposure to radiation. If the mission permits, avoid handling objects suspected of being contaminated with fallout. If your mission does not require you to enter a contaminated area, stay out.

8.8.2. Protect equipment by covering with plastic sheets, tarps, or anything else to minimize the chance of fallout contamination. Park vehicles in hangars, garages, or under covered areas. Keep all doors, windows, or canopies closed to keep the fallout out.

8.8.3. Shelters protect us from radioactive fallout. If possible, take shelter prior to the arrival of fallout. Any sort of overhead cover is better than nothing. A poncho, paper, cardboard, or

any other expedient cover may be your only available shelter if you are outside when fallout arrives.

### **8.9. Nuclear Decontamination.**

You cannot neutralize radioactive contamination; you can only remove it. Also, items exposed to fallout do NOT become radioactive themselves. Simply remove the fallout and the item is safe to use. You can do this by washing your vehicles equipment and yourself.

8.9.1. Many things can be used to decontaminate radioactive fallout. No specific equipment is issued to you for this purpose. Pressurized water, brooms, mops, brushes, soap, and water, etc. can remove radioactive contamination.

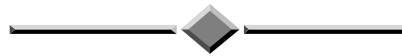
### **8.10. Depleted Uranium (DU).**

Depleted Uranium (DU) is an extremely dense metal used for protective shielding or in munitions to penetrate heavy armor. Exposure and incidents to DU may occur at anytime there is damage to a DU armor package or when an item (such as a vehicle) is hit with a DU munition.

8.10.1. DU presents a moderate hazard to personnel; however, if handled correctly, it causes little risk. Just remember the following: 1) minimize time near the radioactive source, 2) maximize the distance between the source and yourself, and 3) improve the shielding by using tape, cardboard, etc.

8.10.2. DU's primary health hazard is heavy metal toxicity. If it remains in the body it may cause kidney damage, tissue decay, and/or affect body processes. This will depend on whether it was ingested, inhaled, or enters the body through open wounds.

8.10.3. DU's secondary health hazard is from ionizing radiation. It is primarily an alpha particle hazard although beta particles and gamma rays are also emitted. If the alpha particles get inside your body, the internal tissues absorb the energy causing internal damage.



## CHAPTER 9 - COMMAND AND CONTROL

This chapter outlines command relationships that exist in a deployed environment.

### 9.1. The Command Post.

The Command Post, sometimes referred to as the Wing Operations Center (WOC), is the installation's primary command and control nerve center. The Command Post, in conjunction with the Survival Recovery Center (SRC), implements operational plans and priorities; controls and monitors mission generation capabilities; and ensures installation survivability. The host installation commander normally establishes the Command Post. Some installations use other names for this function, such as the Group Operations Center (GOC) or the Crisis Action Team (CAT).

### 9.2. The Survival Recovery Center (SRC).

The SRC coordinates and conducts tactical planning and contingency response activities, and major accident and natural disaster response/recovery actions to mitigate effects, save lives, and restore mission capability. The SRC collects and analyzes status reports from unit control centers and reports up-channel to the senior commander through the CP/WOC. See Figure 9.1. for typical SRC command relationships.

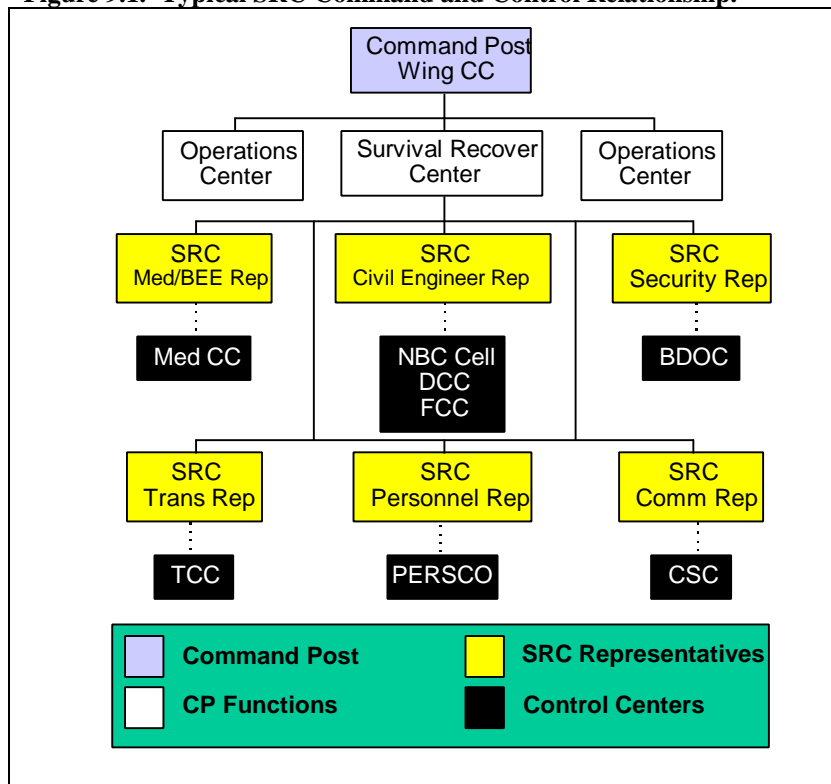
9.2.1. Major contingency response activities controlled by the SRC are:



9.2.1.1. **Passive defense** -- measures for hardening; dispersal; camouflage, concealment and deception; nuclear, biological, and chemical defense.

9.2.1.2. **Recovery actions** -- damage assessment, fire, casualties, and suspected contamination; unexploded ordnance reconnaissance, rapid runway repair, expedient utility and facility repair, and contamination control.

**Figure 9.1. Typical SRC Command and Control Relationship.**



### 9.3. Unit Control Centers.

Functional or unit control centers (UCCs) dispatch and control their resources, and provide status reports up-channel to the SRC. They control work priorities, disseminate information, and

interact with other installation control elements to ensure mission accomplishment.

9.3.1. Some key functional control centers are described below:

9.3.1.1. **Operations Control Center** controls aircrews, tactics, mission planning and other aspects of the flying mission.

9.3.1.2. **Maintenance Operations Center (MOC)** is responsible for the launch, recovery, service, parking, and maintenance of aircraft; tracking of priorities and missions of specific aircraft; and coordinates with fuels and supply functions.

9.3.1.3. **Air Terminal Operations Center (ATOC)** controls aerial port functions including cargo and passenger processing and loading.

9.3.1.4. **Damage Control Center (DCC)** controls damage assessment and recovery teams; coordinates priorities and monitors facility, runway, and taxiway repairs.

9.3.1.5. **Services Control Center (SCC)** is responsible for controlling all services functions to include: food services, billeting, laundry, recreation and fitness, and mortuary affairs.

9.3.1.6. **Medical Control Center (MCC)** provides the medical status of the hospital/clinic, supports medical requirements including requisitioning supplies, establishes casualty collection points, dispatches ambulances, and coordinates patient movement via surface and air.

9.3.1.7. **Personnel Control Center (PCC)** is responsible for personnel accountability, replacement, and managing a manpower pool for the WOC.

9.3.1.8. **Base Defense Operations Center (BDOC)** serves as the focal point for ABD and security measures.

9.3.1.9. **Nuclear, Biological, and Chemical Control Center (NBCCC)** controls NBC reconnaissance teams, plots and predicts downwind hazards, and reports NBC contamination to the SRC. The NBCCC coordinates with unit shelter management and contamination control teams.

9.3.1.10. **Transportation Control Center (TCC)** controls the distribution of transportation assets (i.e., pick-up trucks, forklifts, etc.) and sets priorities for vehicle maintenance.



## CHAPTER 10 - SELF AID AND BUDDY CARE

**10.1. First Aid Fundamentals.**

First aid is treatment for the sick and injured before a trained person can give regular medical or surgical treatment. The medics cannot be everywhere and depend on you and your knowledge of first aid in an emergency. See Tables 10.1. thru 10.9.

<b>TABLE 10.1. BASIC LIFE SAVING STEPS.</b>	
STEP	ACTION
#1	Establish an open airway.
#2	Ensure breathing.
#3	Stop bleeding.
#4	Prevent or treat shock.
#5	Dress and bandage wounds and splint fractures.

<b>TABLE 10.2. GENERAL NOTES FOR CARE WHILE DEPLOYED.</b>	
<input checked="" type="checkbox"/>	Always drink plenty of water from a medically approved source.
<input checked="" type="checkbox"/>	Watch out for your co-workers.
<input checked="" type="checkbox"/>	Transport the wounded before the dead.
<input checked="" type="checkbox"/>	Do not touch or breathe on burns.
<input checked="" type="checkbox"/>	For burns, do not apply antiseptic other than those approved.
<input checked="" type="checkbox"/>	Do not break or drain blisters.
<input checked="" type="checkbox"/>	Do not remove or change dressings.
<input checked="" type="checkbox"/>	Seek medical attention immediately for 2d & 3d degree burns.

<b>TABLE 10.3. HEALTH HAZARDS AND PRECAUTIONS.</b>	
<b>HAZARD</b>	<b>PRECAUTIONS</b>
<b>Heat</b>	<ul style="list-style-type: none"> <li><input checked="" type="checkbox"/> Can incapacitate you without much warning and may cause coma and death.</li> <li><input checked="" type="checkbox"/> Drink fluids (water) frequently--1-2 quarts per hour during moderate work in temperatures over 82 degrees.</li> <li><input checked="" type="checkbox"/> Take appropriate rest breaks.</li> <li><input checked="" type="checkbox"/> The Chemical/Biological protective overgarment increases the need for drinking water, too (i.e., not just ambient temperature).</li> </ul>
<b>Local Water</b>	<ul style="list-style-type: none"> <li><input checked="" type="checkbox"/> Can cause serious illness and may contain parasites.</li> <li><input checked="" type="checkbox"/> Only consume water and ice from a medically approved source.</li> </ul>
<b>Local Food</b>	<ul style="list-style-type: none"> <li><input checked="" type="checkbox"/> Can cause serious illness and may contain parasites.</li> <li><input checked="" type="checkbox"/> Do NOT eat local foods.</li> <li><input checked="" type="checkbox"/> Eat only U.S. military approved foods.</li> <li><input checked="" type="checkbox"/> Wash your hands before eating and after using the latrine.</li> </ul>

<b>TABLE 10.3. HEALTH HAZARDS AND PRECAUTIONS Continued.</b>	
<b>HAZARD</b>	<b>PRECAUTIONS</b>
<b>Insects</b>	<ul style="list-style-type: none"> <li><input checked="" type="checkbox"/> May transmit life-threatening disease.</li> <li><input checked="" type="checkbox"/> Use insect repellent on exposed skin.</li> <li><input checked="" type="checkbox"/> Pretreat flight suits/BDUs with permethrine spray in the yellow can. One can per uniform.</li> <li><input checked="" type="checkbox"/> Sleep under a bed net treated with permethrine--tuck bed netting under the mattress all around.</li> <li><input checked="" type="checkbox"/> Do NOT wear "flea collars".</li> </ul>
<b>Animals</b>	<ul style="list-style-type: none"> <li><input checked="" type="checkbox"/> May transmit rabies and other life-threatening diseases.</li> <li><input checked="" type="checkbox"/> Avoid contact with ALL animals.</li> <li><input checked="" type="checkbox"/> If bitten or scratched, seek medical attention immediately.</li> </ul>
<b>Rivers, Lakes, Swamps, Canals</b>	<ul style="list-style-type: none"> <li><input checked="" type="checkbox"/> May contain parasites that can penetrate unprotected skin and cause serious illness.</li> <li><input checked="" type="checkbox"/> Avoid standing, stagnant water and open sewers. These attract mosquitoes and other disease vectors.</li> <li><input checked="" type="checkbox"/> Do NOT swim or bathe in rivers, lakes, swamps, or canals.</li> <li><input checked="" type="checkbox"/> If you must wade, avoid direct contact between your skin and the water if possible.</li> </ul>
<b>Malaria</b>	<ul style="list-style-type: none"> <li><input checked="" type="checkbox"/> If you are going to a malaria risk area, take malaria pills as prescribed--malaria is a killer.</li> </ul>

<b>TABLE 10.4. PSYCHOLOGICAL EMERGENCIES.</b>
Psychological emergencies are just as real and dangerous as other medical disorders. The principles of treatment are simple:
<input checked="" type="checkbox"/> Respect everyone's right to their own feelings.
<input checked="" type="checkbox"/> Accept emotional disability as being as real as physical disorders.
<input checked="" type="checkbox"/> Use things that are familiar to the victim, such as names.
<input checked="" type="checkbox"/> Encourage the victim to talk.
<input checked="" type="checkbox"/> Give clear and simple instructions.
<input checked="" type="checkbox"/> Do not allow your actions to hinder your ability to render assistance.
<input checked="" type="checkbox"/> Be patient—do not become overly sympathetic.
<input checked="" type="checkbox"/> Help the victim regain confidence.
<input checked="" type="checkbox"/> Let the victim know you expect him/her to recover.
<i>Remember:</i> There is an emotional reaction attached to ALL physical injuries. There is more strength in a disturbed person than what appears.



<b>TABLE 10.5. COLD RELATED INJURIES AND TREATMENT.</b>		
<b>INJURY</b>	<b>SYMPTOMS</b>	<b>TREATMENT</b>
Hypothermia	Body is cold under clothing May be violently shivering May be confused May appear dead	<input checked="" type="checkbox"/> Move to warm place <input checked="" type="checkbox"/> Remove wet clothing <input checked="" type="checkbox"/> Put on warm clothes or wrap with dry blanket <input checked="" type="checkbox"/> Do NOT rub body parts <input checked="" type="checkbox"/> Do NOT give alcohol
Frostbite	Skin has white or waxy appearance Skin hard to the touch	<input checked="" type="checkbox"/> Move to warm place <input checked="" type="checkbox"/> Rewarm the affected area in warm water 104-108° F for 15-30 minutes (NOT hot water) <input checked="" type="checkbox"/> Cover with several layers of dry clothing <input checked="" type="checkbox"/> Do NOT rub affected area <input checked="" type="checkbox"/> Seek medical attention immediately

<b>TABLE 10.6. SHOCK SYMPTOMS AND TREATMENT.</b>	
<b>SYMPTOMS</b>	<b>TREATMENT</b>
<ul style="list-style-type: none"> <li><input checked="" type="checkbox"/> Confusion, restlessness, anxiety, listlessness</li> <li><input checked="" type="checkbox"/> Cold, clammy, pale, and blue skin (if dark-skinned, check under nails, eyelids, or inside mouth)</li> <li><input checked="" type="checkbox"/> Profuse sweating</li> <li><input checked="" type="checkbox"/> Breathing shallow, labored, and rapid</li> <li><input checked="" type="checkbox"/> Rapid pulse</li> <li><input checked="" type="checkbox"/> Eyes dull and pupils dilated</li> <li><input checked="" type="checkbox"/> Thirsty</li> <li><input checked="" type="checkbox"/> Nausea and vomiting</li> </ul>	<ul style="list-style-type: none"> <li><input checked="" type="checkbox"/> Keep the person calm, warm, and comfortable</li> <li><input checked="" type="checkbox"/> Elevate lower extremities at least 12 inches (not with head or neck wound)</li> <li><input checked="" type="checkbox"/> Keep airway open</li> <li><input checked="" type="checkbox"/> Prevent loss of body heat</li> <li><input checked="" type="checkbox"/> <b>NO EATING OR DRINKING</b></li> <li><input checked="" type="checkbox"/> If unconscious, place on side and monitor airway</li> </ul>

<b>TABLE 10.7. INJURY RECOGNITION AND TREATMENT.</b>		
<b>INJURY</b>	<b>SYMPTOMS</b>	<b>TREATMENT</b>
Eye Injury	Obvious pain or injury	<ul style="list-style-type: none"> <li><input checked="" type="checkbox"/> Apply bandage to BOTH eyes</li> </ul>
Abdominal Wound	Internal organs out of body	<ul style="list-style-type: none"> <li><input checked="" type="checkbox"/> DO NOT REPLACE ORGANS IN BODY</li> <li><input checked="" type="checkbox"/> Cover exposed organs with clean, moist, dressing if available</li> <li><input checked="" type="checkbox"/> Secure with bandages</li> <li><input checked="" type="checkbox"/> Place victim in sitting position with legs drawn up, if possible</li> <li><input checked="" type="checkbox"/> Observe for shock--treat as necessary</li> </ul>
Bleeding (External)	Obvious bleeding	<ul style="list-style-type: none"> <li><input checked="" type="checkbox"/> Apply direct pressure</li> <li><input checked="" type="checkbox"/> Elevate the extremity (if no fractures are suspected)</li> <li><input checked="" type="checkbox"/> Use pressure points</li> <li><input checked="" type="checkbox"/> Apply a tourniquet only as a LAST resort--it is rarely necessary, can cause loss of limb</li> <li><input checked="" type="checkbox"/> Observe for shock--treat as necessary</li> <li><input checked="" type="checkbox"/> Do NOT remove dressing until medical help is received--add more dressing over old if needed</li> </ul>

<b>TABLE 10.7. INJURY RECOGNITION AND TREATMENT Continued.</b>		
<b>INJURY</b>	<b>SYMPTOMS</b>	<b>TREATMENT</b>
Bleeding (Internal)	May be agitated or restless Pulse weak and rapid Skin cold, clammy, and pale Eyes dull and pupils dilated Thirsty, Listless Nausea and vomiting Inside abdomen-may be rigid and/or bruised	<ul style="list-style-type: none"> <li><input checked="" type="checkbox"/> Observe for shock--treat as necessary</li> <li><input checked="" type="checkbox"/> Arrange for rapid transportation</li> </ul>
	Extremities (arms and legs) may be warm and swollen	<ul style="list-style-type: none"> <li><input checked="" type="checkbox"/> Apply splint to injury</li> <li><input checked="" type="checkbox"/> Observe for shock--treat as necessary</li> </ul>
Chest Wound	Sucking noise from wound Frothy red blood around wound Bullet hole	<ul style="list-style-type: none"> <li><input checked="" type="checkbox"/> Cover holes with air tight seal (i.e., tin foil, ID card)</li> <li><input checked="" type="checkbox"/> Tape down 3 sides, leave bottom slot uncovered</li> <li><input checked="" type="checkbox"/> Allow victim to assume position for easiest breathing</li> <li><input checked="" type="checkbox"/> Observe for shock--treat as necessary</li> <li><input checked="" type="checkbox"/> Look for entry and exit wound</li> </ul>

TABLE 10.8. FRACTURES RECOGNITION AND TREATMENT.		
INJURY	SYMPTOMS	TREATMENT
Fractures	Deformity, bruising Tenderness Grating noise Swelling and discoloration Loss of function An open fracture, bone is exposed Closed fracture may not be obvious	<ul style="list-style-type: none"> <li><input checked="" type="checkbox"/> Do not straighten part</li> <li><input checked="" type="checkbox"/> If in doubt splint injury-- where they lie if possible</li> <li><input checked="" type="checkbox"/> Remove clothing from injured area (NOT IN CHEMICAL ENVIRONMENT)</li> <li><input checked="" type="checkbox"/> Remove rings from fingers, if possible</li> <li><input checked="" type="checkbox"/> Check pulse below injury (away from heart)</li> <li><input checked="" type="checkbox"/> Splint joints <u>above</u> and <u>below</u> injury</li> </ul>
Spinal/ Neck Injury (includes head injury)	Lack of feeling and/or control anywhere below neck Victim cannot move legs	<ul style="list-style-type: none"> <li><input checked="" type="checkbox"/> If conscious, caution victim not to move</li> <li><input checked="" type="checkbox"/> Check airway without turning head</li> <li><input checked="" type="checkbox"/> Immobilize the head and neck</li> <li><input checked="" type="checkbox"/> IF VICTIM MUST BE MOVED: <ul style="list-style-type: none"> <li>- Use hard surface for litter (door, cut lumber, etc.)</li> <li>- Use as many people as needed to place victim on litter</li> <li>- One person must stabilize the head and neck.</li> </ul> </li> </ul>

TABLE 10.8. FRACTURES RECOGNITION AND TREATMENT Continued.		
INJURY	SYMPTOMS	TREATMENT
<p><i>Warning:</i> DO NOT BEND NECK/ SPINAL COLUMN</p>	<p>Victim has been struck sharply on back or neck Unconscious</p>	<ul style="list-style-type: none"> <li>- One person must control head and neck area--do not bend spinal cord</li> <li>- Secure head to litter</li> <li><input checked="" type="checkbox"/> IF VICTIM <u>CANNOT</u> BE MOVED:               <ul style="list-style-type: none"> <li>- Secure head if possible</li> <li>- Treat for shock</li> </ul> </li> </ul>

<b>TABLE 10.9. BURNS AND HEAT INJURIES AND TREATMENT.</b>		
<b>INJURY</b>	<b>SYMPTOMS</b>	<b>TREATMENT</b>
1st Degree Burn	Reddened skin Painful to touch Slight swelling	<input checked="" type="checkbox"/> Apply or soak in cool water until burning stops <input checked="" type="checkbox"/> Do NOT use butter, grease, or oil on any burn
2d Degree Burn	Blistered skin Painful to touch	<input checked="" type="checkbox"/> Soak in or apply cool water until burning stops <input checked="" type="checkbox"/> Cover blisters with clean dressing <input checked="" type="checkbox"/> Remove rings from fingers, if possible <input checked="" type="checkbox"/> Observe for and treat for shock as necessary
3d Degree Burn	Charred skin Not painful to touch	<input checked="" type="checkbox"/> Cover with clean dressing (do NOT remove adhered particles of charred clothing) <input checked="" type="checkbox"/> Observe for shock <input checked="" type="checkbox"/> Seek medical attention immediately

<b>TABLE 10.9. BURNS AND HEAT INJURIES AND TREATMENT Continued.</b>		
<b>INJURY</b>	<b>SYMPTOMS</b>	<b>TREATMENT</b>
Heat Exhaustion	Cramps in abdomen or limbs Pale face Dizziness/faintness/ weakness Loss of appetite Nausea or vomiting Profuse sweating Moist, cool skin Weak pulse Normal body temperature	<input checked="" type="checkbox"/> Treat for shock <input checked="" type="checkbox"/> Lay person down in cool area <input checked="" type="checkbox"/> Loosen/open clothing <input checked="" type="checkbox"/> Cool body by sprinkling with cool water or fanning (not to point of shivering) <input checked="" type="checkbox"/> Give victim cool water to drink if conscious, add 2 tablespoons of salt to 1 canteen if available <input checked="" type="checkbox"/> Seek medical attention
Heat Stroke	Headache Dizziness Red face/skin Hot, dry skin (no sweating) Strong, rapid pulse High body temperature (hot to touch)	<input checked="" type="checkbox"/> Treat for shock <input checked="" type="checkbox"/> Lay person down in cool area <input checked="" type="checkbox"/> Loosen/open clothing <input checked="" type="checkbox"/> Cool body by sprinkling with cool water or fanning (not to point of shivering) <input checked="" type="checkbox"/> Give victim cool water to drink if conscious, add 2 tablespoons of salt to 1 canteen if available <input checked="" type="checkbox"/> Seek immediate medical attention



## CHAPTER 11 - AUXILIARY FIRE FIGHTING

### 11.1. Fire Reporting and Fighting.

Regular firefighters may be engaged in mission-priority crash rescue and fire suppression tasks involving aircraft and weapons systems. Everyone should know how to report fires and have a basic knowledge of fire fighting procedures. Table 11.1. and 11.2. provides essential reporting and fire fighting tasks.

<b>TABLE 11.1. FIRE REPORTING &amp; FIGHTING PROCEDURES</b>	
<b>1. Sound the alarm</b>	
<input checked="" type="checkbox"/> Let everyone in the immediate area know of the fire. <input checked="" type="checkbox"/> Use a fire triangle or other alarm, if available. <input checked="" type="checkbox"/> If an alarm is not available, shout, bang on metal, etc.	
<b>2. Notify the fire department, UCC or SRC</b>	
<input checked="" type="checkbox"/> Telephone No.	
<b>3. Report the following information:</b>	
<input checked="" type="checkbox"/> Name	<input checked="" type="checkbox"/> Rank
<input checked="" type="checkbox"/> Telephone extension, radio net or other means of contact	
<input checked="" type="checkbox"/> Location of fire--tent number, building number, etc.	
<input checked="" type="checkbox"/> Nature of emergency	
<input checked="" type="checkbox"/> Status of personnel: injured, evacuated, etc.	
<b>4. Evacuate the area</b>	
<input checked="" type="checkbox"/> Evacuate 100 ft from tent city.	<input checked="" type="checkbox"/> Account for <u>All</u> personnel.
<b>5. Implement the following initial fire fighting procedures</b>	
<input checked="" type="checkbox"/> Know the location and operation of fire extinguishers.	
<input checked="" type="checkbox"/> Fight small fires within the limitation of the extinguisher.	
<input checked="" type="checkbox"/> Always maintain a fire escape route.	

<b>TABLE 11.2. BASIC FIRE FIGHTING METHODS</b>	
<b>TYPE</b>	<b>METHODS</b>
Structural Fire	<ul style="list-style-type: none"> <li><input checked="" type="checkbox"/> Do not enter the building, fire fighting is very limited for untrained people.</li> </ul>
Vehicle Fire	<ul style="list-style-type: none"> <li><input checked="" type="checkbox"/> You can usually put out a fuel ignition with a portable fire extinguisher.</li> <li><input checked="" type="checkbox"/> If the fuel tank has ruptured--do NOT attempt to attack the fire.</li> </ul>
Electrical Fire	<ul style="list-style-type: none"> <li><input checked="" type="checkbox"/> Be extremely cautious with an electrical fire, never use water.</li> <li><input checked="" type="checkbox"/> Attempt to shut off power by throwing the main switch or disconnecting a fuse at the main service box.</li> <li><input checked="" type="checkbox"/> Only use a TYPE C fire extinguisher; you should contact the Fire Protection Flight for fire extinguisher training before it's needed.</li> </ul>
Gas Fire (natural/propane)	<ul style="list-style-type: none"> <li><input checked="" type="checkbox"/> Turn the gas off at the gas shutoff valve and fight fire as structural or tent city.</li> </ul>

<b>TABLE 11.2. BASIC FIRE FIGHTING METHODS Continued.</b>	
<b>TYPE</b>	<b>METHODS</b>
Tent City (Bare Base)	<ul style="list-style-type: none"> <li>☑ Fire spreads with alarming speed in a tent city. An adequate water supply can also be a problem—a bare base water system may not be sufficient to support a sustained firefighting effort. By the time an alternative water source is found, the entire compound may be engulfed in flames.</li> <li>☑ Your best course of action may be to simply try to stop the fire from spreading to unaffected tents. One way of doing this is to drop all tentage near the tent on fire. Another effective course of action, (assuming water is available) is to hose down the other tents in the area.</li> </ul>
Ground Cover	<ul style="list-style-type: none"> <li>☑ Ground cover fires include fires in weeds, grass, brush, and similar vegetation. Fighting a ground fire can be very dangerous.</li> <li>☑ Once the ground cover fire starts, it may burn very rapidly. If the fire is small, you may attack it directly if adequate amounts of water are available. You may have to pull back until firebreaks are cut.</li> </ul>

WILLIAM P. HALLIN, Lt General, USAF  
DCS/Installations & Logistics


## **Attachment 1** **ABBREVIATIONS, ACRONYMS, AND TERMS**

### *Abbreviations and Acronyms*

ABD	Air Base Defense
ACCA	Aircrew Contamination Control Area
AFOSI	Air Force Office of Special Investigation
AFSC	Air Force Specialty Code
ALAD	Automatic Liquid Agent Detector
ATOC	Air Terminal Operations Center
BB	Bare Base
BDO	Battle Dress Overgarment
BDOC	Base Defense Operations Center
BOI	Basis of Issue
BW	Biological Warfare
C <sup>2</sup>	Command and Control
CANA	Convulsion, Antidote, Nerve Agent
CAM	Chemical Agent Monitor
CAT	Crisis Action Team
CB	Chemical, Biological
CCA	Contamination Control Areas
CCD	Camouflage, Concealment, and Deception
CHA	Contact Hazard Area
CMBCC	Consolidated Mobility Bag Control Center
COB	Collocated Operating Base
ColPro	Collective Protection
CONUS	Continental United States
CP	Command Post
CRT	Chaplain Readiness Teams
CW	Chemical Warfare
CWC	Chemical Weapons Convention

DC	Defense Counsel
DCC	Damage Control Center
DNA	Recombinant Deoxyribonucleic Acid
DU	Depleted Uranium
EMP	Electromagnetic Pulse
EOD	Explosive Ordnance Disposal
EOR	Explosive Ordnance Reconnaissance
GCE	Groundcrew Ensemble
GOC	Group Operations Center
IED	Improvised Explosive Device
IPE	Individual Protective Equipment
JA	Judge Advocate
JSLIST	Joint Service Lightweight Integrated Suite Technology
LDA	Lightweight Decontamination Apparatus
LOAC	Law of Armed Conflict
MCC	Medical Control Center
MOB	Main Operating Base
MOC	Maintenance Operations Center
MOPP	Mission Oriented Protective Posture
NBC	Nuclear, Biological, Chemical
NBCCC	Nuclear, Biological, and Chemical Control Center
PCC	Personnel Control Center
PERSCO	Personnel Support for Contingency Operations
POW	Prisoner of War
Prime BEEF	Prime Base Engineer Emergency Force
Prime RIBS	Prime Readiness in Base Services
RPG	Rocket-Propelled Grenade
ROE	Rules of Engagement
SCC	Services Control Center
SOF	Special Operation Forces
SRC	Survival Recovery Center
TALCE	Tanker Airlift Control Elements
TBM	Tactical Ballistic Missile

TFA	Toxic Free Area
ThreatCon	Threat Conditions
UCC	Unit Control Center
UCMJ	Uniform Code of Military Justice
UV	Ultraviolet
UXO	Unexploded Ordnance
VHA	Vapor Hazard Area
WMD	Weapons of Mass Destruction
WOC	Wing Operations Center
WRM	War Reserve Material



---

**Use this page to insert local information**

---

---

---

---

---

---

---

---

---

---

---

---

---

---

---

---

---

---

---

---

---

---

---

---

---

---

---

